

LED DESIGN INNOVATION CATALOGUE 2020

éclairage Led technique / musées - magasins

email : patrick.faggian@sfr.fr

tel : 06.11.50.82.02

site web : www.led-design-innovation.com

OVEGA

Imax-T Series

ONE SOLUTION for many beam angle challenges. IMAX-T family Track Lights provide first-class options for architects, lighting designers who want superior flexibility in an LED accent lighting system.

In versions with different light solutions, IMAX-T covers high performance accent lighting with different interchangeable beam lens and beam angle adjusting from a 15° narrow to a 90° wide in a sharp outline or from a 15° narrow to a 70° wide in a soft outline.

IMAX is a complete family with both track mounted and recessed spotlights with different light solutions. So, if you have an environment with different types of ceilings it will be possible to use the same spotlight family and get a unified impression.

Overview

| | |
|------------------------|---|
| Application: | On track |
| Light source: | COB LED |
| SDCM: | <3 |
| Light solution: | Beam angle adjustable(15°-90° or 15° -70°) Fixed lens: 15°, 24°, 38°, 60° |
| Watt: | 15W - 30W |
| CCT: | 2700K, 3000K, 4000K, 5000K |
| CRI: | 80+, 90+ |
| Luminous: | 579lm-2259lm |
| Control option: | On/off, Triac, DALI |
| Color: | White, Black, Silver |

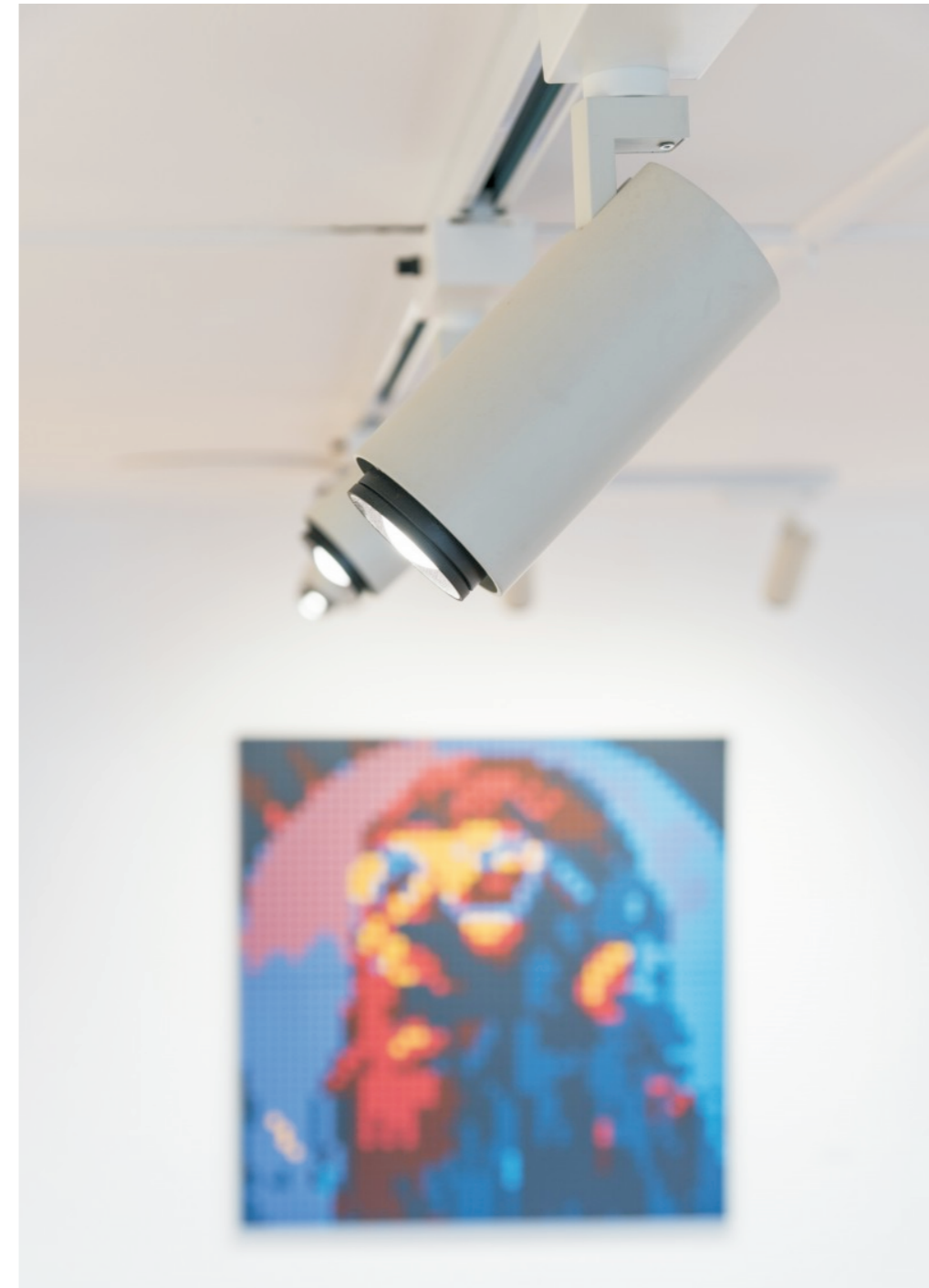

I max-T Series

Fixed Lens

Beam Angle Adjustable

I max-T Fixed Lens Version

Model: EN-TLI015-03
EN-TLI015-04(Built-in Dimmer)
Beam Angle: 15°, 24°, 38°, 60°
Application: On track



I max-T Zoomable Version

Model: EN-TLI015-01
EN-TLI015-02(Built-in Dimmer)
EN-TLI020-01
EN-TLI020-02(Built-in Dimmer)
Beam Angle: 15 -90° with sharp outline
15-70° with soft outline
Application: On track;



I max-T Fixed Lens Version

Model: EN-TLI020-03
EN-TLI020-04(Built-in Dimmer)
Beam Angle: 15°, 24°, 38°, 60°
Application: On track



I max-T Zoomable Version

Model: EN-TLI030-01
EN-TLI030-02(Built-in Dimmer)
Beam Angle: 15 -90° with sharp outline
15-70° with soft outline
Application: On track;



I max-T Fixed Lens Version

Model: EN-TLI030-03
EN-TLI030-04(Built-in Dimmer)
Beam Angle: 15°, 24°, 38°, 60°
Application: On track



ONE SOLUTION FOR MANY BEAM ANGLE CHALLENGES

15°-90° / 15°-70°

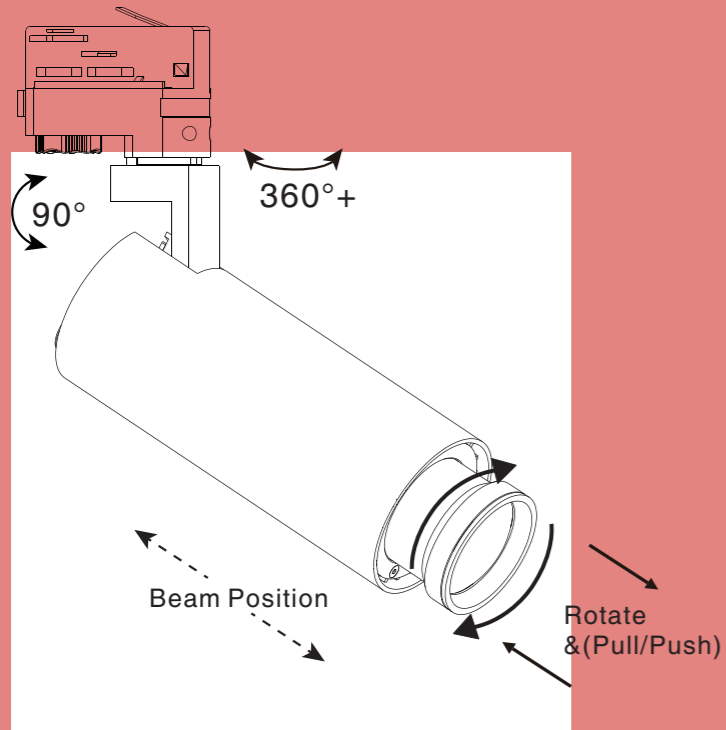

IMAX-T(EN-TLI series, zoomable version) is a slim and clean LED track light that will fit smoothly into any museum, exhibition and gallery environments. Featuring an adjustable beam mechanism designed to provide endless beam options from a 15° narrow to a 90° wide with sharp outline or from a 15° narrow to a 70° wide with soft outline. The head can be adjusted precisely 360°+ horizontal(rotation) and 90° vertical without dead angle. The light, as a result, is emitted exactly where you need it. Every IMAX-T contains a built-in dimmer, to smoothly control the light from 100% to 5%, creating the right individual scenery.

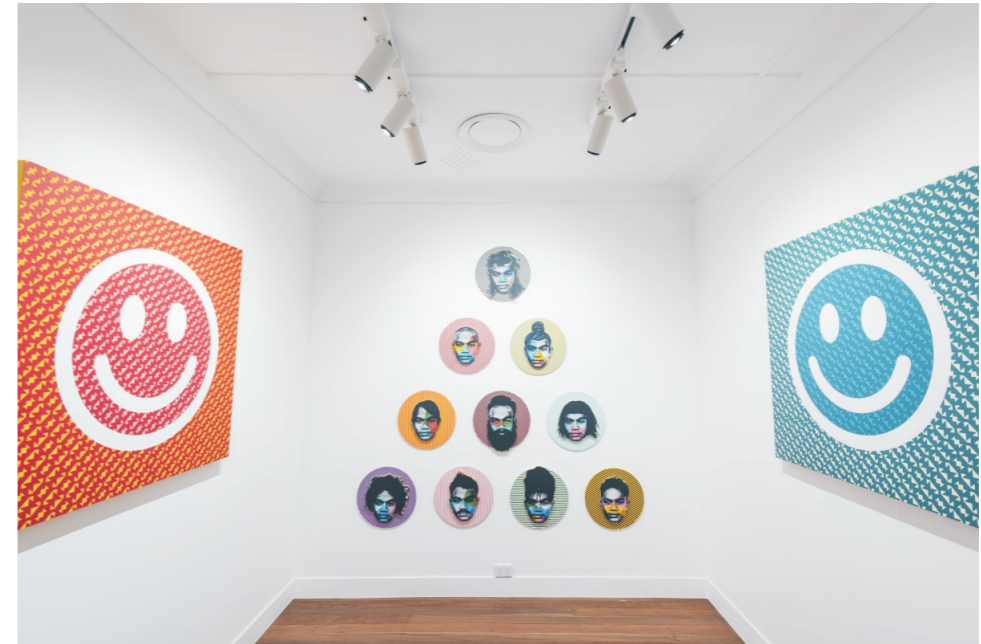

Lighting Solutions:

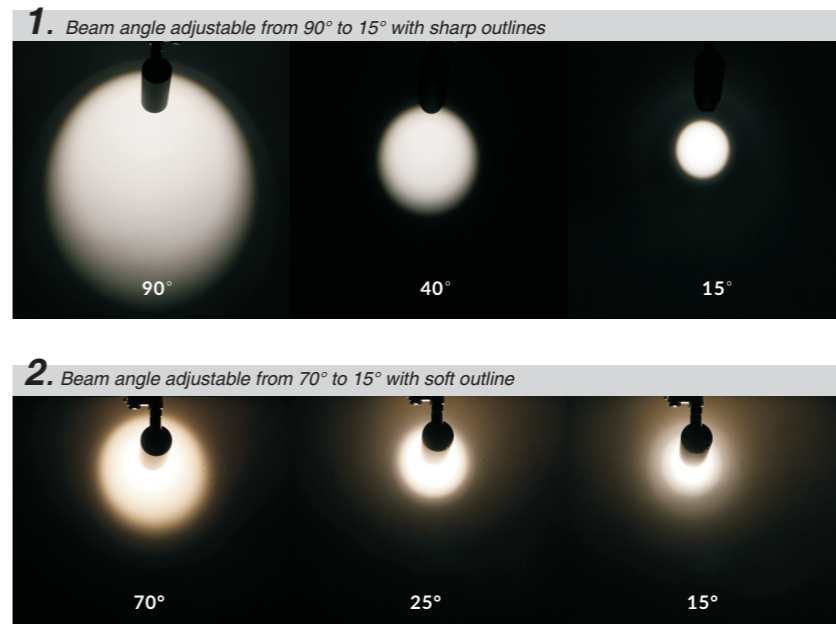

Accessories:





EN-TLI015-01/02
EN-TLI020-01/02



Imax-T with built-in Dimmer



Imax-T with honeycomb and barn door



EN-TLI030-01/02

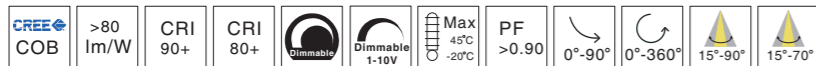

MAIN FEATURES:

- Slim and clean design with integrated driver(15W, 20W).
- By adjusting the focal length, the beam angle can be changed from 15° to 90° with sharp outline or from 15° to 70° with soft outline.
- Privately-designed joints can hold the track head at any positions without malfunctions.
- Self-dimming is available thanks to built-in dimmer (0/1-10V dimming).
- 360° + rotatable without dead angle and 90° vertical aiming(15W, 20W).



EN-TLI015-01

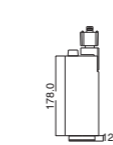

3-pin track adaptor

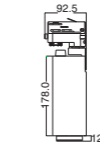

4-pin track adaptor



3000K

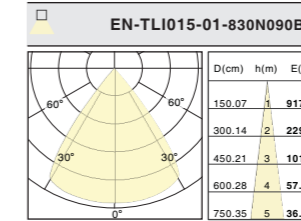
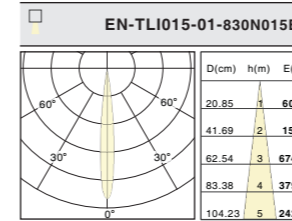
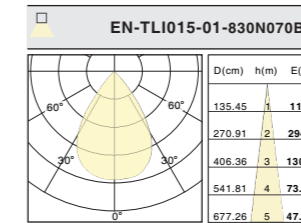
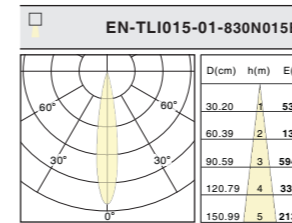

| Order info. | Power | Led Current | Luminous Flux(lm) | CRI | CCT | Beam Angle (°) |
|-----------------------|-------|-------------|-------------------|-----|-------|----------------|
| EN-TLI015-01-830N015B | 15 W | 350mA | 579 lm | 80+ | 3000K | 15° |
| EN-TLI015-01-840N015B | 15 W | 350mA | 610 lm | 80+ | 4000K | 15° |
| EN-TLI015-01-830N070B | 15 W | 350mA | 1301 lm | 80+ | 3000K | 70° |
| EN-TLI015-01-840N070B | 15 W | 350mA | 1370 lm | 80+ | 4000K | 70° |
| EN-TLI015-01-830N015B | 15 W | 350mA | 303 lm | 80+ | 3000K | 15° |
| EN-TLI015-01-840N015B | 15 W | 350mA | 319 lm | 80+ | 4000K | 15° |
| EN-TLI015-01-830N090B | 15 W | 350mA | 1136 lm | 80+ | 3000K | 90° |
| EN-TLI015-01-830N090B | 15 W | 350mA | 1196 lm | 80+ | 4000K | 90° |

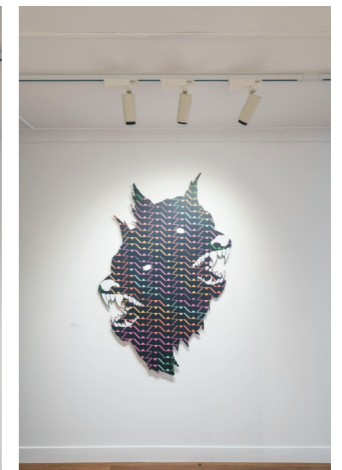
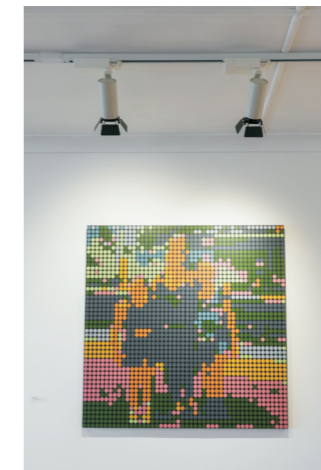

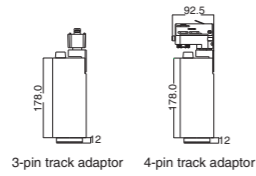

3000K

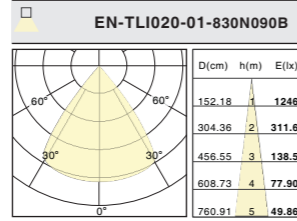
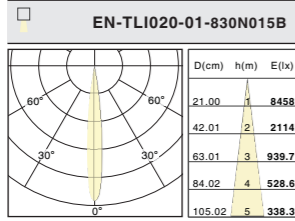
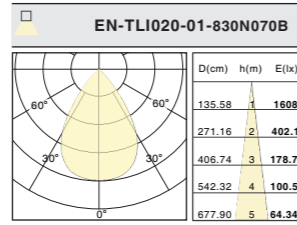
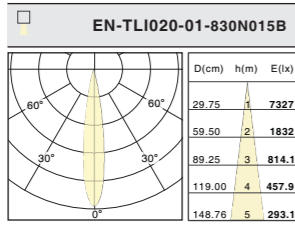

| Order info. | Power | Led Current | Luminous Flux(lm) | CRI | CCT | Beam Angle (°) |
|-----------------------|-------|-------------|-------------------|-----|-------|----------------|
| EN-TLI020-01-830N015B | 20 W | 500mA | 794 lm | 80+ | 3000K | 15° |
| EN-TLI020-01-840N015B | 20 W | 500mA | 836 lm | 80+ | 4000K | 15° |
| EN-TLI020-01-830N070B | 20 W | 500mA | 1784 lm | 80+ | 3000K | 70° |
| EN-TLI020-01-840N070B | 20 W | 500mA | 1878 lm | 80+ | 4000K | 70° |
| EN-TLI020-01-830N015B | 20 W | 500mA | 421 lm | 80+ | 3000K | 15° |
| EN-TLI020-01-840N015B | 20 W | 500mA | 443 lm | 80+ | 4000K | 15° |
| EN-TLI020-01-830N090B | 20 W | 500mA | 1573 lm | 80+ | 3000K | 90° |
| EN-TLI020-01-840N090B | 20 W | 500mA | 1656 lm | 80+ | 4000K | 90° |

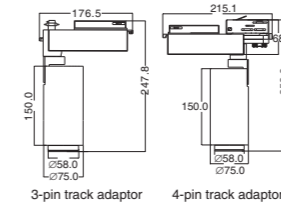

3000K

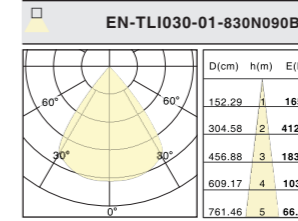
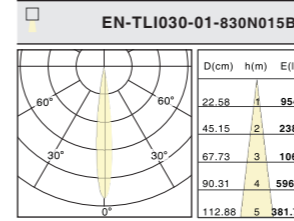
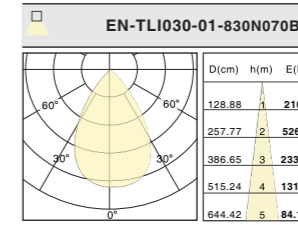
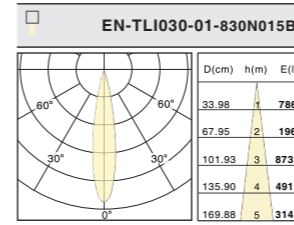

| Order info. | Power | Led Current | Luminous Flux(lm) | CRI | CCT | Beam Angle (°) |
|-----------------------|-------|-------------|-------------------|-----|-------|----------------|
| EN-TLI030-01-830N015B | 30 W | 700mA | 1043 lm | 80+ | 3000K | 15° |
| EN-TLI030-01-840N015B | 30 W | 700mA | 1098 lm | 80+ | 4000K | 15° |
| EN-TLI030-01-830N070B | 30 W | 700mA | 2259 lm | 80+ | 3000K | 70° |
| EN-TLI030-01-840N070B | 30 W | 700mA | 2378 lm | 80+ | 4000K | 70° |
| EN-TLI030-01-830N015B | 30 W | 700mA | 541 lm | 80+ | 3000K | 15° |
| EN-TLI030-01-840N015B | 30 W | 700mA | 569 lm | 80+ | 4000K | 15° |
| EN-TLI030-01-830N090B | 30 W | 700mA | 2045 lm | 80+ | 3000K | 90° |
| EN-TLI030-01-840N090B | 30 W | 700mA | 2153 lm | 80+ | 4000K | 90° |



IMAX-T (EN-TLI series, fixed lens version) is a slim and clean LED track light that will fit smoothly into any retail and gallery environments. Every IMAX-T contains a built-in dimmer, to smoothly control the light from 100% to 5%, creating the right individual scenery. The head can be adjusted precisely 360°+ horizontal (rotation) and 90° vertical without dead angle. The light, as a result, is emitted exactly where you need it.



MAIN FEATURES:

- Slim and clean design with integrated driver (15W, 20W).
- Light efficiency is up to 95lm/W.
- Interchangeable lens: 15°, 24°, 38°, 60°.
- Privately-designed joints can hold the track head at any position without malfunctions.
- Self-dimming is available thanks to built-in dimmer (0/1-10V dimming).
- 360°+ rotatable without dead angle and 90° vertical aiming (15W, 20W).

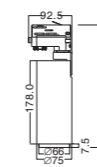
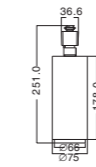

3000K

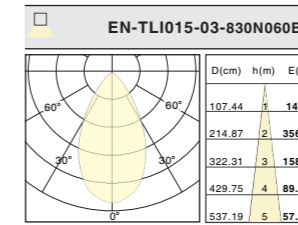
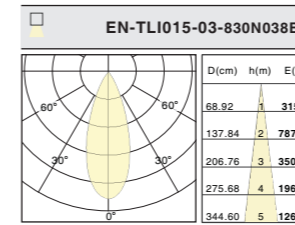
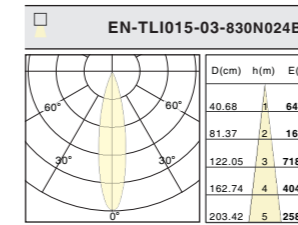
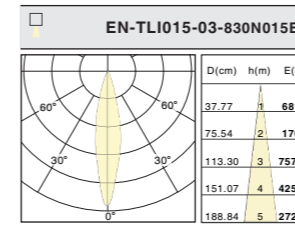

| Order info. | Power | Led Current | Luminous Flux(lm) | CRI | CCT | Beam Angle (°) |
|-----------------------|-------|-------------|-------------------|-----|-------|----------------|
| EN-TLI015-03-830N015B | 15 W | 350mA | 1291 lm | 80+ | 3000K | 15° |
| EN-TLI015-03-840N015B | 15 W | 350mA | 1359 lm | 80+ | 4000K | 15° |
| EN-TLI015-03-830N024B | 15 W | 350mA | 1473 lm | 80+ | 3000K | 24° |
| EN-TLI015-03-840N024B | 15 W | 350mA | 1551 lm | 80+ | 4000K | 24° |
| EN-TLI015-03-830N038B | 15 W | 350mA | 1495 lm | 80+ | 3000K | 38° |
| EN-TLI015-03-840N038B | 15 W | 350mA | 1574 lm | 80+ | 4000K | 38° |
| EN-TLI015-03-830N060B | 15 W | 350mA | 1290 lm | 80+ | 3000K | 60° |
| EN-TLI015-03-840N060B | 15 W | 350mA | 1358 lm | 80+ | 4000K | 60° |



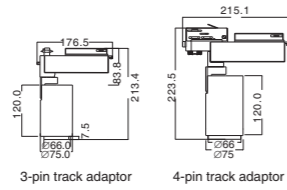

3000K

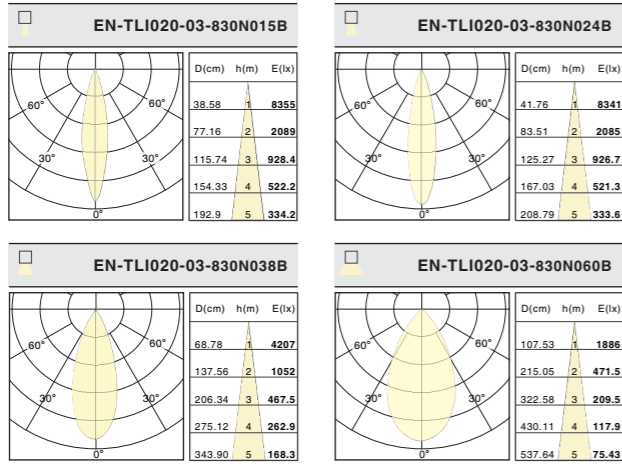

| Order info. | Power | Led Current | Luminous Flux(lm) | CRI | CCT | Beam Angle (°) |
|-----------------------|-------|-------------|-------------------|-----|-------|----------------|
| EN-TLI020-03-830N015B | 20 W | 500mA | 1714 lm | 80+ | 3000K | 15° |
| EN-TLI020-03-840N015B | 20 W | 500mA | 1804 lm | 80+ | 4000K | 15° |
| EN-TLI020-03-830N024B | 20 W | 500mA | 1941 lm | 80+ | 3000K | 24° |
| EN-TLI020-03-840N024B | 20 W | 500mA | 2043 lm | 80+ | 4000K | 24° |
| EN-TLI020-03-830N038B | 20 W | 500mA | 1996 lm | 80+ | 3000K | 38° |
| EN-TLI020-03-840N038B | 20 W | 500mA | 2101 lm | 80+ | 4000K | 38° |
| EN-TLI020-03-830N060B | 20 W | 500mA | 1716 lm | 80+ | 3000K | 60° |
| EN-TLI020-03-840N060B | 20 W | 500mA | 1806 lm | 80+ | 4000K | 60° |

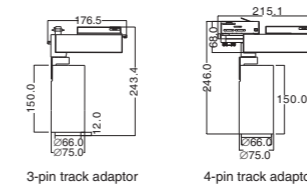

3000K

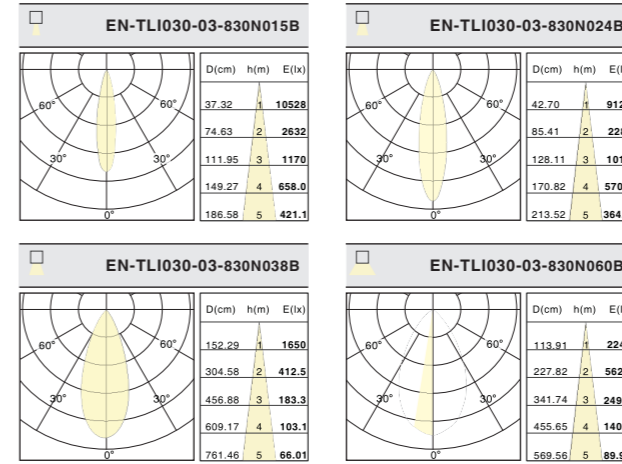

| Order info. | Power | Led Current | Luminous Flux(lm) | CRI | CCT | Beam Angle (°) |
|-----------------------|-------|-------------|-------------------|-----|-------|----------------|
| EN-TLI030-03-830N015B | 30 W | 700mA | 2311 lm | 80+ | 3000K | 15° |
| EN-TLI030-03-840N015B | 30 W | 700mA | 2432 lm | 80+ | 4000K | 15° |
| EN-TLI030-03-830N024B | 30 W | 700mA | 2569 lm | 80+ | 3000K | 24° |
| EN-TLI030-03-840N024B | 30 W | 700mA | 2704 lm | 80+ | 4000K | 24° |
| EN-TLI030-03-830N038B | 30 W | 700mA | 2540 lm | 80+ | 3000K | 38° |
| EN-TLI030-03-840N038B | 30 W | 700mA | 2674 lm | 80+ | 4000K | 38° |
| EN-TLI030-03-830N060B | 30 W | 700mA | 2320 lm | 80+ | 3000K | 60° |
| EN-TLI030-03-840N060B | 30 W | 700mA | 2442 lm | 80+ | 4000K | 60° |

Mofa Series

MOFA(EN-TLM, projection version) is a functional LED track light that will fit smoothly into any high-end museum, gallery and commercial sites. Featuring a group of precision optical lens and framing patterns mechanism designed to provide sharp-edged, high-contrast square & triangle light shapes, logo projection is also available. The head can be adjusted precisely 360°+ horizontal(rotation) and 90°vertical without dead angle. The light, as a result, is emitted exactly where you need it. The integrated driver gives clean feeling and the ceiling will not be cluttered with drivers aimed in different directions.

Overview

| | |
|------------------------|----------------------------|
| Application: | On track |
| Light source: | COB LED |
| SDCM: | <3 |
| Light solution: | 16° |
| Watt: | 30W |
| CCT: | 2700K, 3000K, 4000K, 5000K |
| CRI: | 80+, 90+ |
| Luminous: | 464lm- 488lm |
| Control option: | On/off, Triac, DALI |
| Color: | White+Black, Black |





Framing patterns:
triangle, square etc.



Customized
LOGO Projection



Dimmable

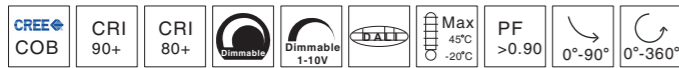
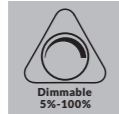

MAIN FEATURES:

- Optimum accent lighting for museums, exhibitions, art galleries and sales and showroom areas.
- Designed for precise, sharp-focused projection of a light field.
- A set of four framing blades and an iris diaphragm bring sharp-edged, high-contrast square & triangle lighting shape at user's convenience.
- Logo projection, customized logo can be projected at your request.
- Self-dimming is available thanks to built-in dimmer.
- 360°+ rotation without dead angle and 90°vertical aiming.

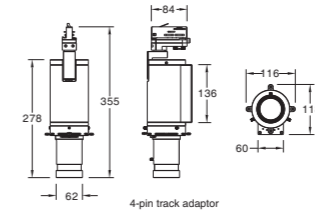

3000K

EN-TLM030-01-830N016W

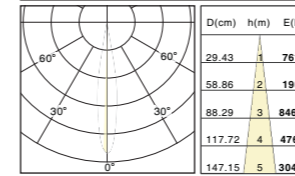

| Order info. | Power | Led Current | Luminous Flux(lm) | CRI | CCT | Beam Angle (°) |
|-----------------------|-------|-------------|-------------------|-----|-------|----------------|
| EN-TLM030-01-830N016W | 30 W | 700mA | 464 lm | 80+ | 3000k | 16° |
| EN-TLM030-01-840N016W | 30 W | 700mA | 488 lm | 80+ | 4000k | 16° |



Optical structure can make any possible lighting shapes.



Adjustable aperture inside to adjust the size of lighting shape

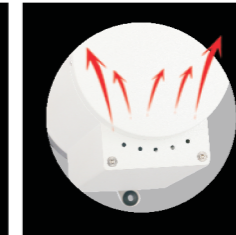

In order to maximize the light body working life, we consider and tailor-made the lamp body cooling hole.



Reliable jointer can hold at any position without loosen.



Framing Patterns
triangle ,square etc

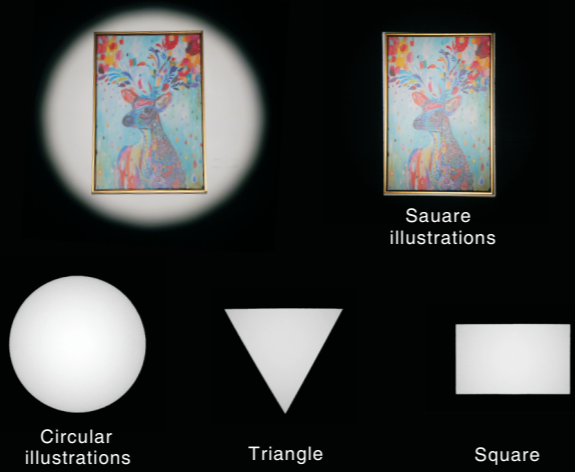
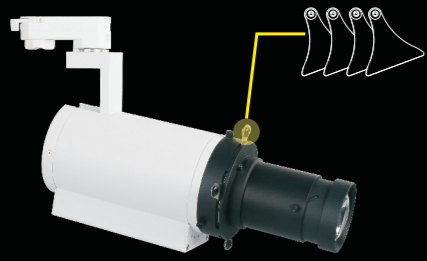

Adjust the **4 framing blades** to control the light shape

Light Beam

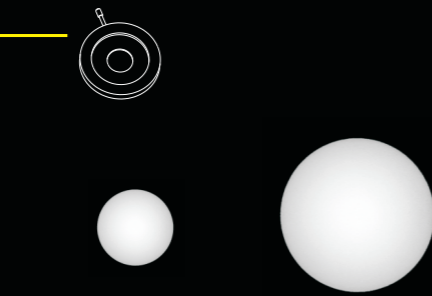

Adjust **iris diaphragm** to control the circular illustration size

Clear or Soft Outline



Adjust **Front snoot** to make the light spot clear or blurred borders

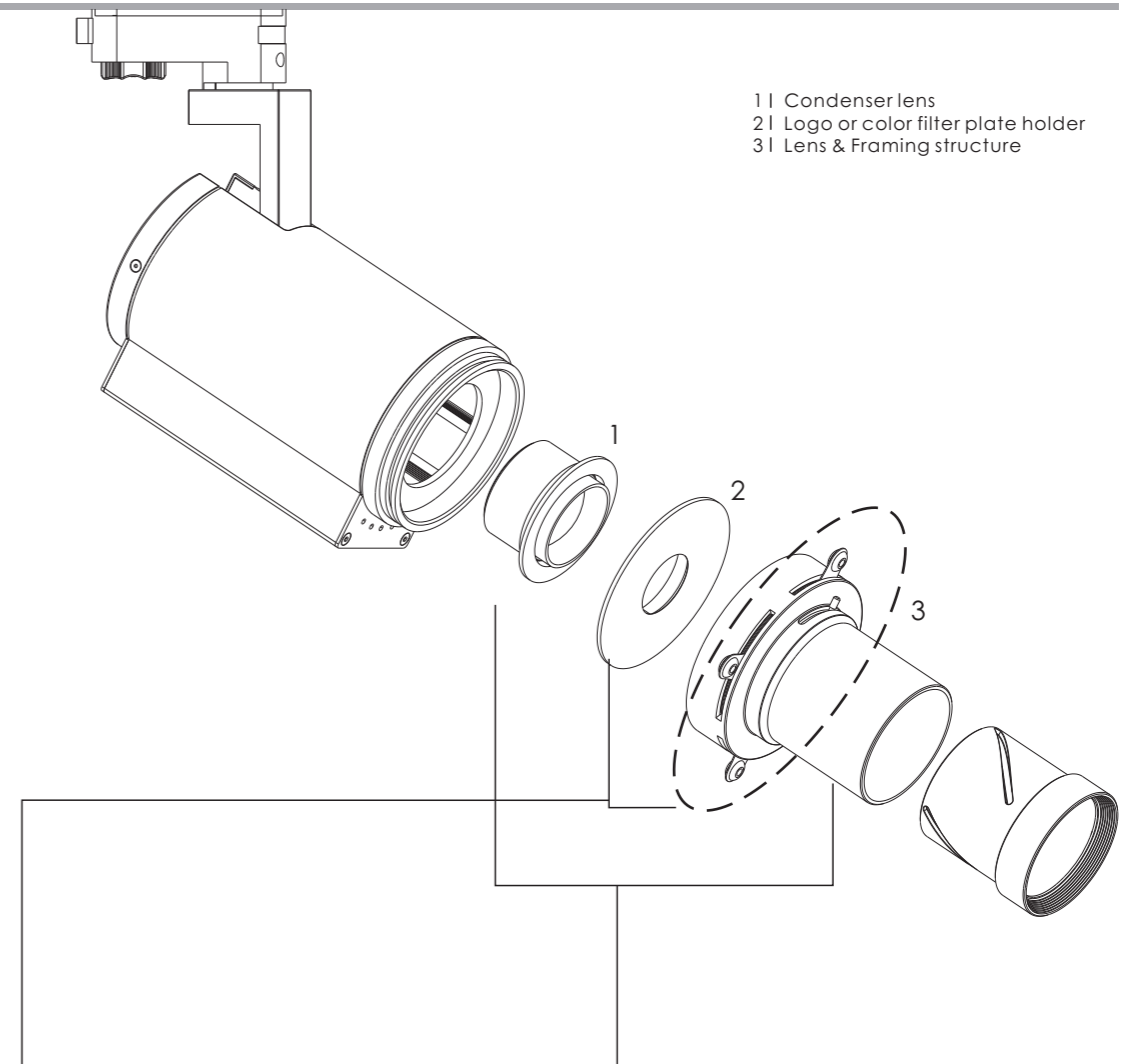
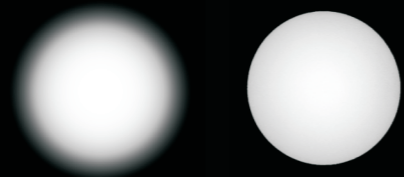

Framing structure + Logo Projection

Through adjustable framing blades and iris diaphragms, can showing off both square and circular exhibits to optimum effect. A built-in plate holder creates ideal logo or color projection.

1. The framing blades controls the light beam for square illustrations.
2. The iris diaphragm controls the light beam for circular illustrations.
3. Logo & color filter projection. Logo can be custerimized.

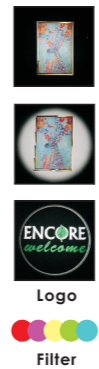

Lenses

Optical structure functions with condenser and objective lens set, provide uniform light distribution and adjustment of resolution. Zooming action can be performed by just turning front ring.

Lenses
Condenser lens
Objective lens

Radiation angles
spot: 16°

Flex Series

UNIQUE in its design, VERSATILE in its using!

A simple, elegant cylinder design with a jointed section that is both easy to adjust and firmly retains its setting, Flex family Track Light always ready to put on a great performance no matter the applications.

In versions with different light solutions, Flex covers high performance accent lighting with different interchangeable beam lens and beam angle adjusting from a 25° narrow to a 60° wide.

Flex is a family with both track mounted and surface mounted spotlights with different light solutions. So, if you have an environment with different types of ceilings it will be possible to use the same spotlight family and get a unified impression.

Overview

| | |
|------------------------|--|
| Application: | On track, Surface-mount |
| Light source: | COB LED |
| SDCM: | <3 |
| Light solution: | Beam angle adjustable(20°-70°) Fixed lens: 15°, 24°, 38°, 60° |
| Watt: | 8W - 25W |
| CCT: | 2700K, 3000K, 4000K, 5000K |
| CRI: | 80+, 90+ |
| Luminous: | 529lm-2580lm |
| Control option: | On/off, Triac, DALI |
| Color: | White, Black, Silver |



Flex Series

Fixed Lens

Beam Angle Adjustable

Flex Fixed Lens Version
Model: EN-TLF020-21
EN-TLF025-21
Beam Angle: 15°, 24°, 38°, 60°
Application: On track



Flex Zoomable Version
Model: EN-TLF020-11
EN-TLF025-11
Beam Angle: 25-60°
Application: On track



Flex Fixed Lens Version
Model: EN-TLF020-22
EN-TLF025-22
Beam Angle: 15°, 24°, 38°, 60°
Application: Surface-mounted



Flex Zoomable Version
Model: EN-TLF020-12
EN-TLF025-12;
Beam Angle: 25 -60°
Application: Surface-mounted



Flex Fixed Lens Version
Model: EN-TLF008-21
Beam Angle: 24°, 38°, 60°
Application: On track



Flex Zoomable Version
Model: EN-TLF008-11
Beam Angle: 25 -70°
Application: On track



BEAM ANGLE ADJUSTABLE

25°-60° / 20°-70°

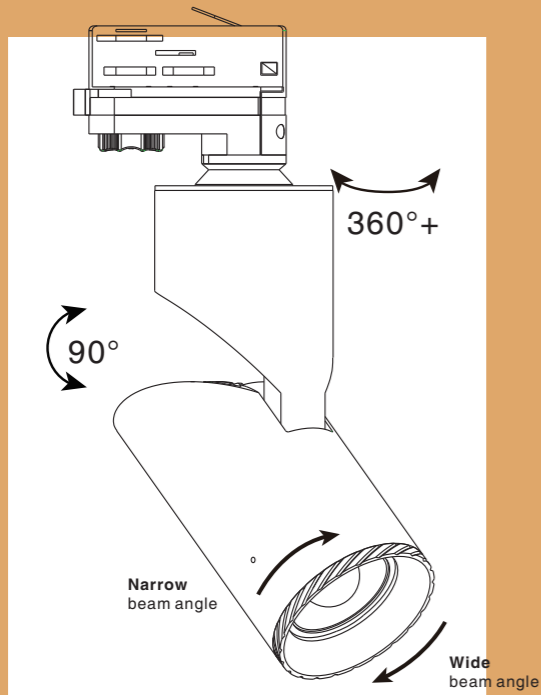

FLEX(EN-TLF series, zoomable version) is a slim cylinder in foldable design LED track light that will fit smoothly into any museum, exhibition and gallery environments. Featured adjustable beam design to provide various options for 25° narrow to 60° wide angle. The head can be adjusted precisely 360°+ horizontally(rotation) and 90°vertically without dead angle. The light, as a result, is emitted exactly where you need it. Support track mount and surface mount.



Beam Angle Adjustable



Beam angle adjustable from 70° to 20°(8W) / 60° to 25°(20W/25W).



20°-70°

25°-60°

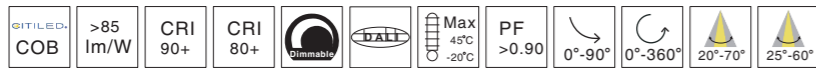

MAIN FEATURES:

- A sleek & elegant cylinder in foldable design, concise but not simple.
- By simply rotate the front ring, the beam angle can adjusted from **25° to 60°**.
- Private-designed joints can hold the track head at any positions without malfunctions.
- Smart magnet can make fixture base and driver box seamless connect.
- **360°+** rotation without dead angle and **90°** vertical aiming.



EN-TLF008-11

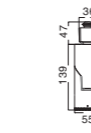

3-pin track adaptor

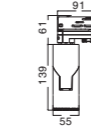

4-pin track adaptor



3000K

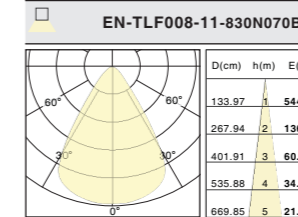
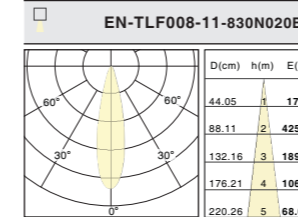

| Order info. | Power | Led Current | Luminous Flux(lm) | CRI | CCT | Beam Angle (°) |
|-----------------------|-------|-------------|-------------------|-----|-------|----------------|
| EN-TLF008-11-830N020B | 8 W | 200mA | 529 lm | 80+ | 3000K | 20° |
| EN-TLF008-11-840N020B | 8 W | 200mA | 563 lm | 80+ | 4000K | 20° |
| EN-TLF008-11-830N070B | 8 W | 200mA | 712 lm | 80+ | 3000K | 70° |
| EN-TLF008-11-840N070B | 8 W | 200mA | 757 lm | 80+ | 4000K | 70° |



EN-TLF020-11

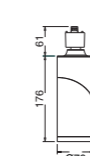

3-pin track adaptor

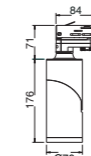

4-pin track adaptor



3000K

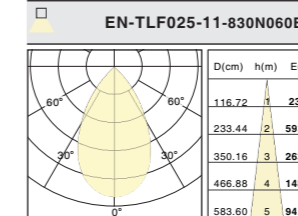
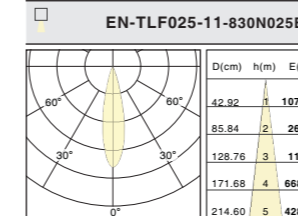
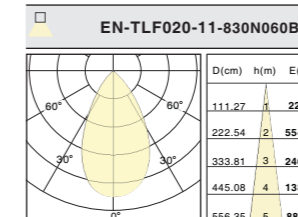
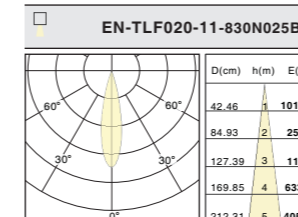

| Order info. | Power | Led Current | Luminous Flux(lm) | CRI | CCT | Beam Angle (°) |
|-----------------------|-------|-------------|-------------------|-----|-------|----------------|
| EN-TLF020-11-830N025B | 20 W | 520mA | 2021 lm | 80+ | 3000K | 25° |
| EN-TLF020-11-840N025B | 20 W | 520mA | 2084 lm | 80+ | 4000K | 25° |
| EN-TLF020-11-830N060B | 20 W | 520mA | 2064 lm | 80+ | 3000K | 60° |
| EN-TLF020-11-840N060B | 20 W | 520mA | 2148 lm | 80+ | 4000K | 60° |
| EN-TLF025-11-830N025B | 25 W | 600mA | 2168 lm | 80+ | 3000K | 25° |
| EN-TLF025-11-840N025B | 25 W | 600mA | 2235 lm | 80+ | 4000K | 25° |
| EN-TLF025-11-830N060B | 25 W | 600mA | 2311 lm | 80+ | 3000K | 60° |
| EN-TLF025-11-840N060B | 25 W | 600mA | 2382 lm | 80+ | 4000K | 60° |

FIXED LENS



FLEX(EN-TLF series, fixed lens version) is a slim cylinder in foldable design LED track light that will fit smoothly into any retail and gallery environments. The front deep ring can bring a good light comfort. The head can be adjusted precisely 360°+ horizontal(rotation) and 90°vertical without dead angle. The light, as a result, is emitted exactly where you need it. Support track mount and surface mount.



MAIN FEATURES:

- A sleek & elegant cylinder in foldable design, concise but not simple.
- Light efficiency is up to 100lm/W.
- Interchangeable lens: 15°, 24°, 38°, 60°
- Private-design joints can hold the track head at any positions without malfunctions.
- Smart magnet can make fixture base and driver box seamless connected.
- 360°+ rotation without dead angle and 90° vertical aiming.

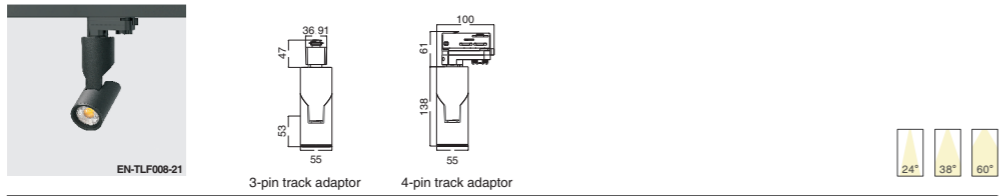

3000K

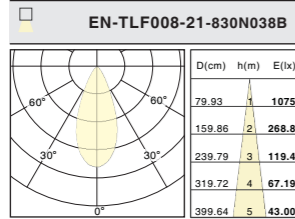

| Order info. | Power | Led Current | Luminous Flux(lm) | CRI | CCT | Beam Angle (°) |
|-----------------------|-------|-------------|-------------------|-----|-------|----------------|
| EN-TLF008-21-830N024B | 8 W | 200mA | 690 lm | 80+ | 3000K | 24° |
| EN-TLF008-21-840N024B | 8 W | 200mA | 719 lm | 80+ | 4000K | 24° |
| EN-TLF008-21-830N038B | 8 W | 200mA | 698 lm | 80+ | 3000K | 38° |
| EN-TLF008-21-840N038B | 8 W | 200mA | 727 lm | 80+ | 4000K | 38° |
| EN-TLF008-21-830N060B | 8 W | 200mA | 693 lm | 80+ | 3000K | 60° |
| EN-TLF008-21-840N060B | 8 W | 200mA | 722 lm | 80+ | 3000K | 60° |

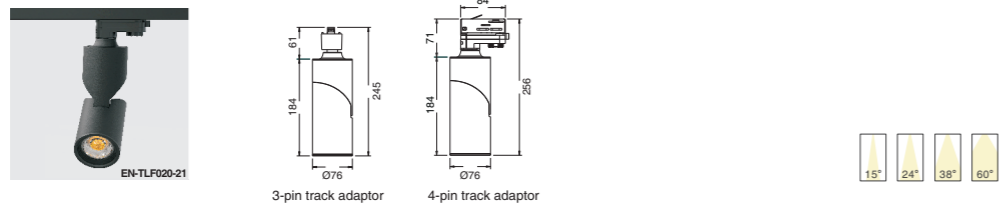

3000K

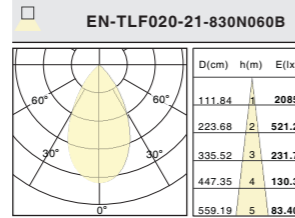
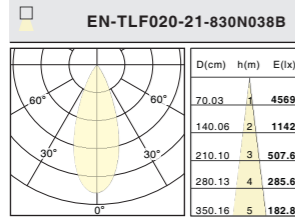
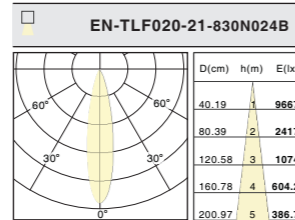
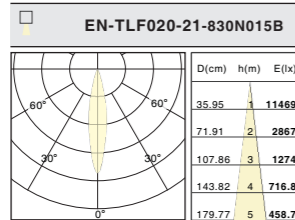

| Order info. | Power | Led Current | Luminous Flux(lm) | CRI | CCT | Beam Angle (°) |
|-----------------------|-------|-------------|-------------------|-----|-------|----------------|
| EN-TLF020-21-830N015B | 20 W | 520mA | 2164 lm | 80+ | 3000K | 15° |
| EN-TLF020-21-840N015B | 20 W | 520mA | 2278 lm | 80+ | 4000K | 15° |
| EN-TLF020-21-830N024B | 20 W | 520mA | 2268 lm | 80+ | 3000K | 24° |
| EN-TLF020-21-840N024B | 20 W | 520mA | 2388 lm | 80+ | 4000K | 24° |
| EN-TLF020-21-830N038B | 20 W | 520mA | 2281 lm | 80+ | 3000K | 38° |
| EN-TLF020-21-840N038B | 20 W | 520mA | 2401 lm | 80+ | 4000K | 38° |
| EN-TLF020-21-830N060B | 20 W | 520mA | 2114 lm | 80+ | 3000K | 60° |
| EN-TLF020-21-840N060B | 20 W | 520mA | 2225 lm | 80+ | 4000K | 60° |

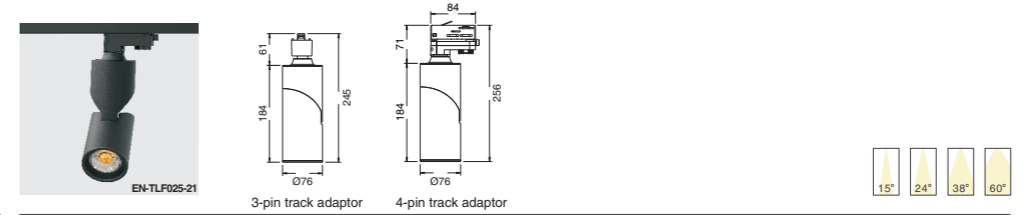

3000K

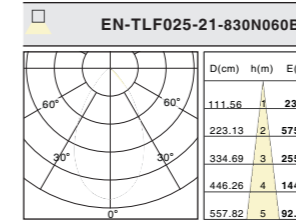
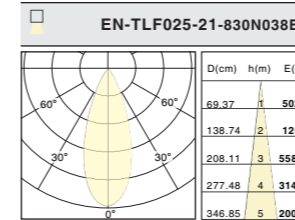
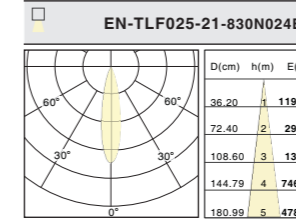
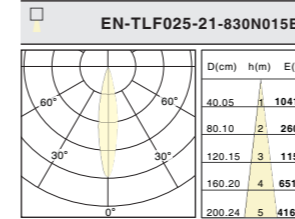

| Order info. | Power | Led Current | Luminous Flux(lm) | CRI | CCT | Beam Angle (°) |
|-----------------------|-------|-------------|-------------------|-----|-------|----------------|
| EN-TLF025-21-830N015B | 25 W | 600mA | 2332 lm | 80+ | 3000K | 15° |
| EN-TLF025-21-840N015B | 25 W | 600mA | 2508 lm | 80+ | 4000K | 15° |
| EN-TLF025-21-830N024B | 25 W | 600mA | 2453 lm | 80+ | 3000K | 24° |
| EN-TLF025-21-840N024B | 25 W | 600mA | 2578 lm | 80+ | 4000K | 24° |
| EN-TLF025-21-830N038B | 25 W | 600mA | 2462 lm | 80+ | 3000K | 38° |
| EN-TLF025-21-840N038B | 25 W | 600mA | 2580 lm | 80+ | 4000K | 38° |
| EN-TLF025-21-830N060B | 25 W | 600mA | 2321 lm | 80+ | 3000K | 60° |
| EN-TLF025-21-840N060B | 25 W | 600mA | 2439 lm | 80+ | 4000K | 60° |

Kingo Series

KINGO(EN-TLK series) is a stylish and cubic LED track light that make the retail, gallery and museum environments looks very special. Optics designed for narrow, medium and wide beams, also can be wall washer, to fulfill different light demands. The driver compartment is integrated in the overall design and maintains a separation from LED for optimal thermal management. The head can be adjusted precisely 360°+ horizontal(rotation) without dead angle and 90°vertical. The light, as a result, is emitted exactly where you need it.

Overview

| | |
|------------------------|--|
| Application: | On track |
| Light source: | COB LED |
| SDCM: | <3 |
| Light solution: | Fixed lens 15°, 20°, 30°, 45°, 60°, 40° × 20°, 60° × 10° |
| Watt: | 30W |
| CCT: | 2700K, 3000K, 4000K, 5000K |
| CRI: | 80+, 90+ |
| Luminous: | 1713lm-2875lm |
| Control option: | On/off, Triac, DALI |
| Color: | White, Black, Silver |



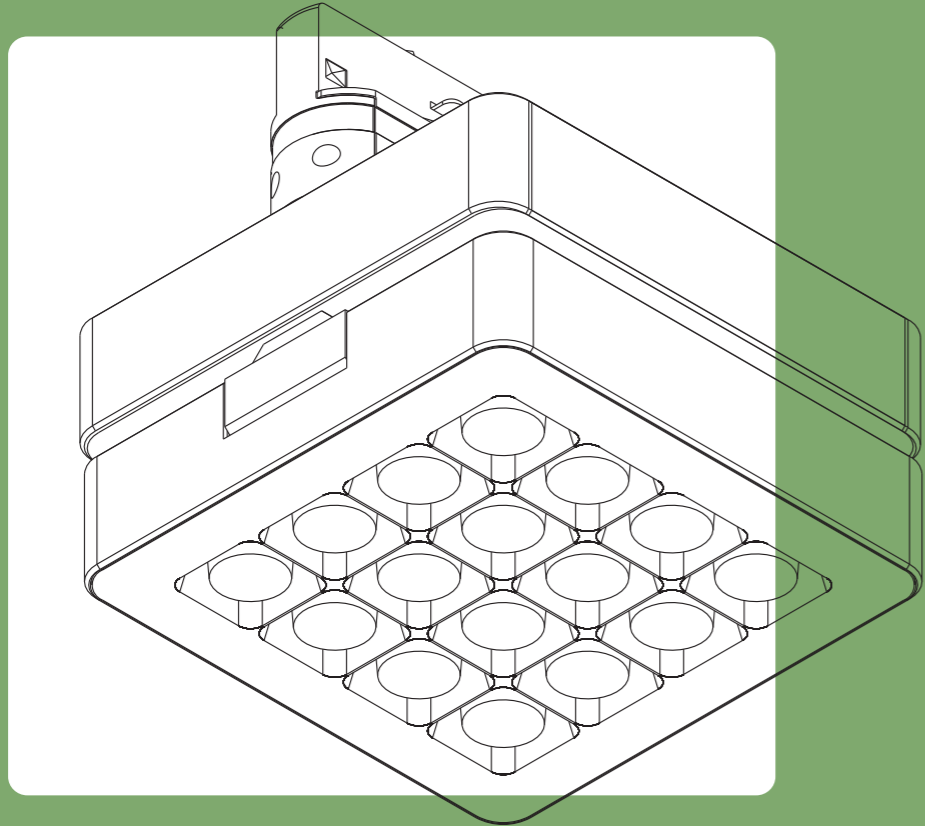

Lighting Solutions:

Spot light

Beam angle:

- 15°
- 20°
- 30°
- 45°
- 60°

asymetrique

éclairage rectangulaire

- 40x20
- 60x10



Objectif différent pour plusieurs possibilités, symétrique - asymétrique

système de refroidissement

dimmer intégré (Gradation 1-10V)

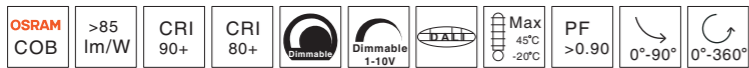
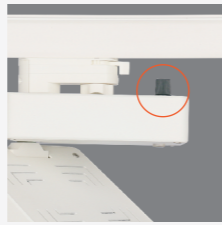

MAIN FEATURES:

- Le chevauchement de deux cubes minces donne à la lumière plus de flexibilité et de créativité.
- Les optiques conçues pour les faisceaux étroits, moyens et larges peuvent également être des lèche-murs.
- Prend en charge la gradation Triac, 1-10V et DALI grâce à suffisamment d'espace dans le boîtier de commande dans une conception cubique. Le joint de conception privée peut maintenir la piste à n'importe quelle position sans dysfonctionnements.
- 360 ° + rotation sans angle mort et visée verticale à 90 °.

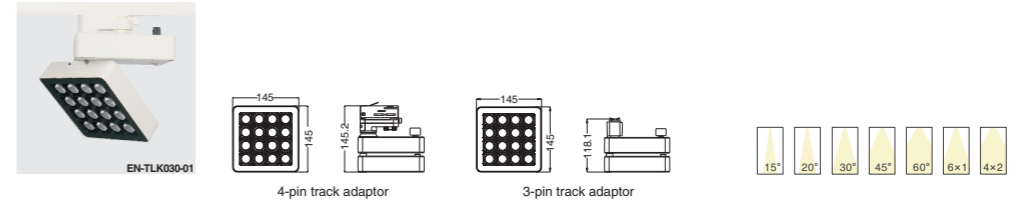

3000K

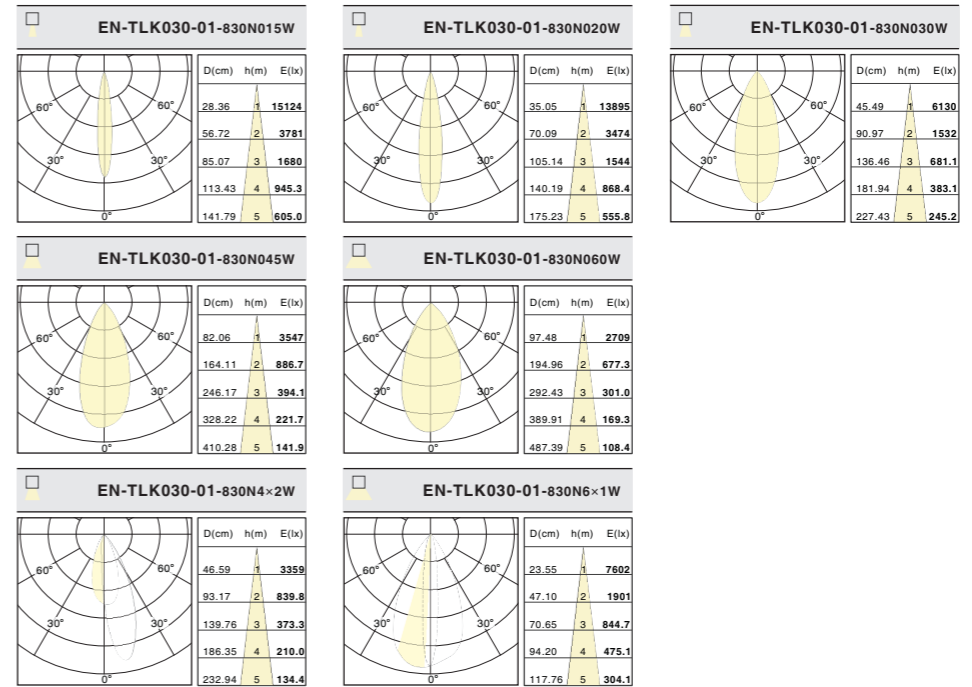

| Order info. | Power | Led Current | Luminous Flux(lm) | CRI | CCT | Beam Angle (°) |
|------------------------|-------|-------------|-------------------|-----|-------|----------------|
| EN-TLK030-01-830N015W | 30 W | 550mA | 2490 lm | 80+ | 3000K | 15° |
| EN-TLK030-01-840N015W | 30 W | 550mA | 2673 lm | 80+ | 4000K | 15° |
| EN-TLK030-01-830N020W | 30 W | 550mA | 2571 lm | 80+ | 3000K | 20° |
| EN-TLK030-01-840N020W | 30 W | 550mA | 2760 lm | 80+ | 4000K | 20° |
| EN-TLK030-01-830N030W | 30 W | 550mA | 2342 lm | 80+ | 3000K | 30° |
| EN-TLK030-01-840N030W | 30 W | 550mA | 2510lm | 80+ | 4000K | 30° |
| EN-TLK030-01-830N045W | 30 W | 550mA | 2448 lm | 80+ | 3000K | 45° |
| EN-TLK030-01-840N045W | 30 W | 550mA | 2612 lm | 80+ | 4000K | 45° |
| EN-TLK030-01-830N060W | 30 W | 550mA | 2360 lm | 80+ | 3000K | 60° |
| EN-TLK030-01-840N060W | 30 W | 550mA | 2530 lm | 80+ | 4000K | 60° |
| EN-TLK030-01-830N04x2W | 30 W | 550mA | 2340 lm | 80+ | 3000K | 20°40° |
| EN-TLK030-01-840N04x2W | 30 W | 550mA | 2510 lm | 80+ | 4000K | 20°40° |
| EN-TLK030-01-830N06x1W | 30 W | 550mA | 2329 lm | 80+ | 3000K | 10°60° |
| EN-TLK030-01-840N06x1W | 30 W | 550mA | 2500 lm | 80+ | 4000K | 10°60° |

Aimer Series

Classic in style, Versatile in use!

Aimer (EN-TLA series) is designed for lighting retail, gallery and exhibition spaces. The driver compartment is separate from the optical compartment, assuring excellent thermal dissipation and a balanced design. Aimer is available in two sizes and in two versions (vertical and flat), support Triac, 1-10V and DALI dimming thanks to enough drive-box space in a unique design. Aimer can also add a built-in dimmer as an option, to smoothly control the light from 100% to 5%, creating the right individual scenery.

Overview

| | |
|------------------------|------------------------------------|
| Application: | On track |
| Light source: | COB LED |
| SDCM: | <3 |
| Light solution: | Fixed lens 10°, 15°, 24°, 38°, 60° |
| Watt: | 15W - 35W |
| CCT: | 2700K, 3000K, 4000K, 5000K |
| CRI: | 80+, 90+ |
| Luminous: | 664lm-3398lm |
| Control option: | On/off, Triac, DALI |
| Color: | White, Black, Silver |



Aimer Series

Aimer - Small

Model: EN-TLA015-01

Beam Angle: 10°, 15°, 24°, 38°, 60°

Application: On track

Support all dimming methods(Triac, 1-10V, DALI)
Customized driver is no problem thanks to enough driver-box space in unique design.



Aimer

Model: EN-TLA015-01
EN-TLA025-01
EN-TLA030-01
EN-TLA035-01

Beam Angle: 15°, 24°, 38°, 60°

Application: On track

Support all dimming methods(Triac, 1-10V, DALI)
Customized driver is no problem thanks to enough driver-box space in unique design.



Aimer

Fly-bird design

Aimer

Self-dimming is available thanks to built-in dimmer (1-10V dimming).



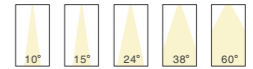
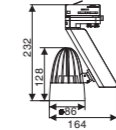
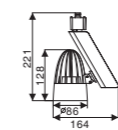

3000K

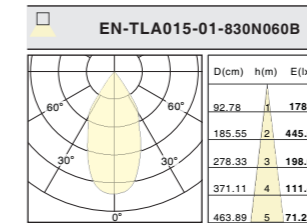
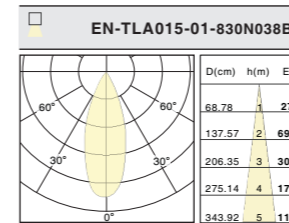
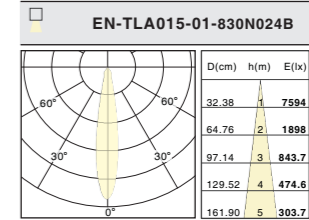
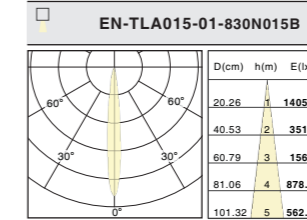
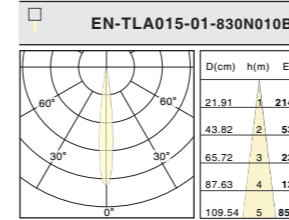

| Order info. | Power | Led Current | Luminous Flux(lm) | CRI | CCT | Beam Angle (°) |
|-----------------------|-------|-------------|-------------------|-----|-------|----------------|
| EN-TLA015-01-830N010B | 15 W | 350mA | 1281 lm | 80+ | 3000K | 10° |
| EN-TLA015-01-840N010B | 15 W | 350mA | 1334 lm | 80+ | 4000K | 10° |
| EN-TLA015-01-830N015B | 15 W | 350mA | 1240 lm | 80+ | 3000K | 15° |
| EN-TLA015-01-840N015B | 15 W | 350mA | 1291 lm | 80+ | 4000K | 15° |
| EN-TLA015-01-830N024B | 15 W | 350mA | 1233 lm | 80+ | 3000K | 24° |
| EN-TLA015-01-840N024B | 15 W | 350mA | 1284 lm | 80+ | 4000K | 24° |
| EN-TLA015-01-830N038B | 15 W | 350mA | 1239 lm | 80+ | 3000K | 38° |
| EN-TLA015-01-840N038B | 15 W | 350mA | 1290 lm | 80+ | 4000K | 38° |
| EN-TLA015-01-830N060B | 15 W | 350mA | 1224 lm | 80+ | 3000K | 60° |
| EN-TLA015-01-840N060B | 15 W | 350mA | 1275 lm | 80+ | 4000K | 60° |



EN-TLA***-01
Standard

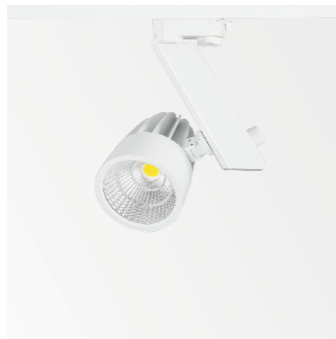

EN-TLA***-02
with Built-in Dimmer(1-10V dimming)



EN-TLA***-03
Fly-bird

MAIN FEATURES:

- Classic in style, Versatile in use.
- Light efficiency is up to 95lm/W.
- Interchangeable reflector: 15°, 24°, 38°, 60°
- Support Triac, 1-10V and DALI dimming thanks to enough drive-box space in a unique design.
- Privately-designed joint can hold the track head at any positions without malfunctions.
- Rotating solution: 355° in horizontal, 355° in vertical.
- Self-dimming is available thanks to built-in dimmer(1-10V dimming).
- Can be equipped with anti-glare honeycomb louver.



EN-TLA025-01

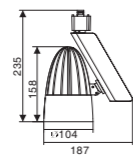

3-pin track adaptor

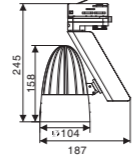

4-pin track adaptor



3000K

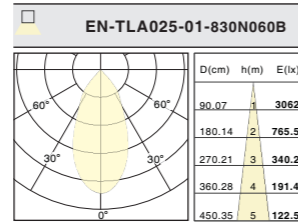
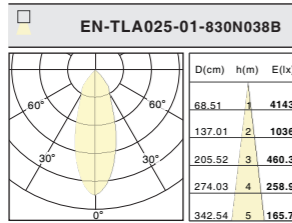
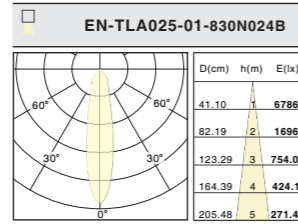
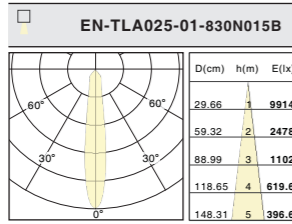

| Order info. | Power | Led Current | Luminous Flux(lm) | CRI | CCT | Beam Angle (°) |
|-----------------------|-------|-------------|-------------------|-----|-------|----------------|
| EN-TLA025-01-830N015B | 25 W | 600mA | 2299 lm | 80+ | 3000K | 15° |
| EN-TLA025-01-840N015B | 25 W | 600mA | 2395 lm | 80+ | 4000K | 15° |
| EN-TLA025-01-830N024B | 25 W | 600mA | 2321 lm | 80+ | 3000K | 24° |
| EN-TLA025-01-840N024B | 25 W | 600mA | 2418 lm | 80+ | 4000K | 24° |
| EN-TLA025-01-830N038B | 25 W | 600mA | 2385 lm | 80+ | 3000K | 38° |
| EN-TLA025-01-840N038B | 25 W | 600mA | 2485 lm | 80+ | 4000K | 38° |
| EN-TLA025-01-830N060B | 25 W | 600mA | 2335 lm | 80+ | 3000K | 60° |
| EN-TLA025-01-840N060B | 25 W | 600mA | 2432 lm | 80+ | 4000K | 60° |



EN-TLA030-01

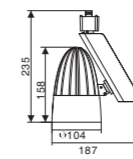

3-pin track adaptor

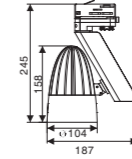

4-pin track adaptor

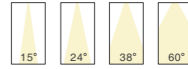

3000K

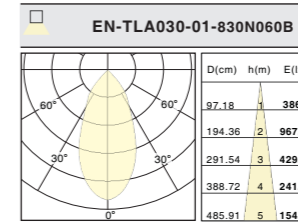
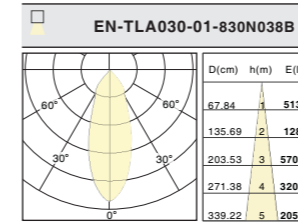
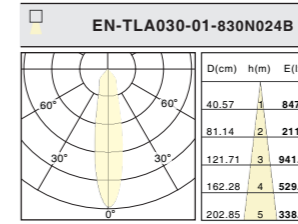
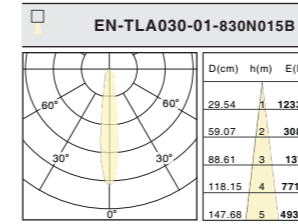

| Order info. | Power | Led Current | Luminous Flux(lm) | CRI | CCT | Beam Angle (°) |
|-----------------------|-------|-------------|-------------------|-----|-------|----------------|
| EN-TLA030-01-830N015B | 30 W | 730mA | 2796 lm | 80+ | 3000K | 15° |
| EN-TLA030-01-840N015B | 30 W | 730mA | 2913 lm | 80+ | 4000K | 15° |
| EN-TLA030-01-830N024B | 30 W | 730mA | 2837 lm | 80+ | 3000K | 24° |
| EN-TLA030-01-840N024B | 30 W | 730mA | 2955 lm | 80+ | 4000K | 24° |
| EN-TLA030-01-830N038B | 30 W | 730mA | 2919 lm | 80+ | 3000K | 38° |
| EN-TLA030-01-840N038B | 30 W | 730mA | 3041 lm | 80+ | 4000K | 38° |
| EN-TLA030-01-830N060B | 30 W | 730mA | 2834 lm | 80+ | 3000K | 60° |
| EN-TLA030-01-840N060B | 30 W | 730mA | 2952 lm | 80+ | 4000K | 60° |



EN-TLA035-01

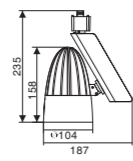

3-pin track adaptor

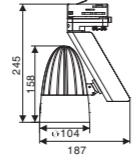

4-pin track adaptor

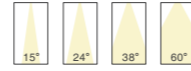

3000K

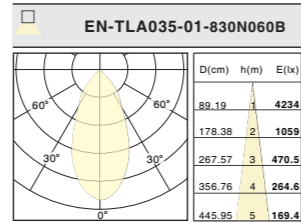
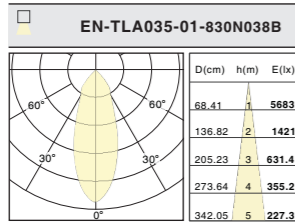
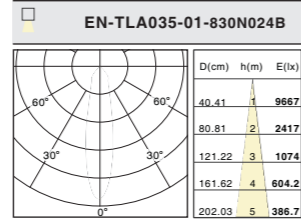
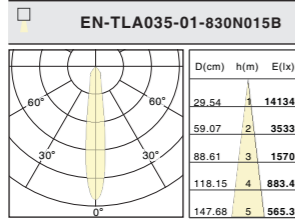

| Order info. | Power | Led Current | Luminous Flux(lm) | CRI | CCT | Beam Angle (°) |
|-----------------------|-------|-------------|-------------------|-----|-------|----------------|
| EN-TLA035-01-830N015B | 35 W | 850mA | 3186 lm | 80+ | 3000K | 15° |
| EN-TLA035-01-840N015B | 35 W | 850mA | 3319 lm | 80+ | 4000K | 15° |
| EN-TLA035-01-830N024B | 35 W | 850mA | 3224 lm | 80+ | 3000K | 24° |
| EN-TLA035-01-840N024B | 35 W | 850mA | 3358 lm | 80+ | 4000K | 24° |
| EN-TLA035-01-830N038B | 35 W | 850mA | 3262 lm | 80+ | 3000K | 38° |
| EN-TLA035-01-840N038B | 35 W | 850mA | 3398 lm | 80+ | 4000K | 38° |
| EN-TLA035-01-830N060B | 35 W | 850mA | 3195 lm | 80+ | 3000K | 60° |
| EN-TLA035-01-840N060B | 35 W | 850mA | 3328 lm | 80+ | 4000K | 60° |



Biro Series

BIRO(EN-TLB series) is designed for lighting retail, gallery and exhibition spaces. The driver compartment is separate from the optical compartment, assuring excellent thermal dissipation and a balanced design. Interchangeable beam reflector can help you to change the beam reflector easily without tools.

Overview

| | |
|------------------------|-------------------------------|
| Application: | On track |
| Light source: | COB LED |
| SDCM: | <3 |
| Light solution: | Fixed lens 15°, 24°, 38°, 60° |
| Watt: | 20W - 30W |
| CCT: | 2700K, 3000K, 4000K, 5000K |
| CRI: | 80+, 90+ |
| Luminous: | 1974lm-2782lm |
| Control option: | On/off, Triac, DALI |
| Color: | White, Black, Silver |



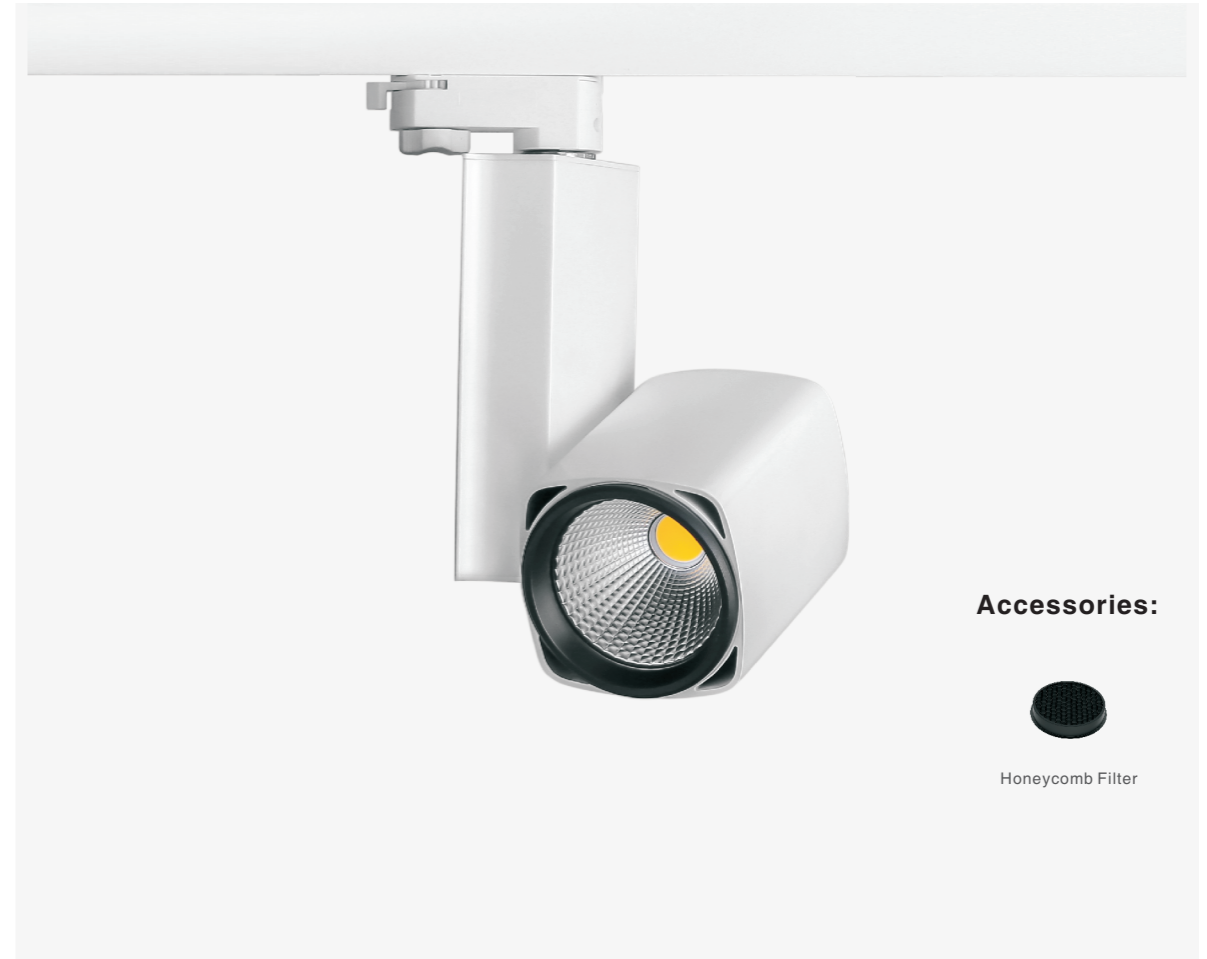

with Honeycomb Filter



MAIN FEATURES:

- Light efficiency is up to 90lm/W.
- Interchangeable reflector: 15°, 24°, 38°, 60°
- Privately-designed joint can hold the track head at any positions without malfunctions.
- Precision aiming adjustment: 355° aiming both horizontal and vertical rotation.
- Can be equipped with anti-glare honeycomb louver.

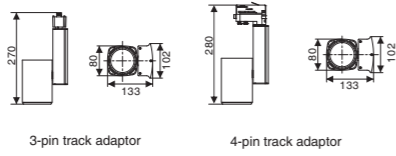

3000K

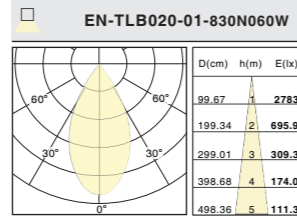
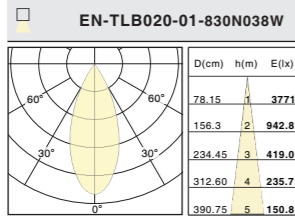
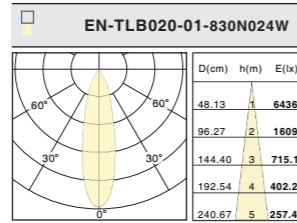
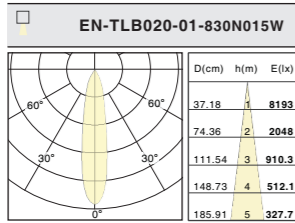

| Order info. | Power | Led Current | Luminous Flux(lm) | CRI | CCT | Beam Angle (°) |
|-----------------------|-------|-------------|-------------------|-----|-------|----------------|
| EN-TLB020-01-830N015W | 20 W | 520mA | 1974 lm | 80+ | 3000K | 15° |
| EN-TLB020-01-840N015W | 20 W | 520mA | 2077 lm | 80+ | 4000K | 15° |
| EN-TLB020-01-830N024W | 20 W | 520mA | 1980 lm | 80+ | 3000K | 24° |
| EN-TLB020-01-840N024W | 20 W | 520mA | 2084 lm | 80+ | 4000K | 24° |
| EN-TLB020-01-830N038W | 20 W | 520mA | 1974 lm | 80+ | 3000K | 38° |
| EN-TLB020-01-840N038W | 20 W | 520mA | 2078 lm | 80+ | 4000K | 38° |
| EN-TLB020-01-830N060W | 20 W | 520mA | 1981 lm | 80+ | 3000K | 60° |
| EN-TLB020-01-840N060W | 20 W | 520mA | 2085 lm | 80+ | 4000K | 60° |

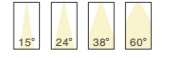
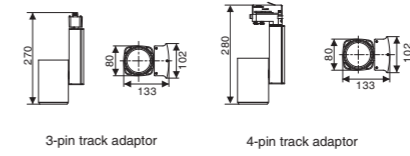
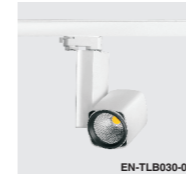

3000K

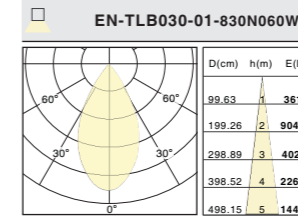
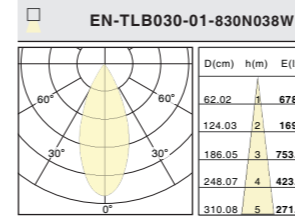
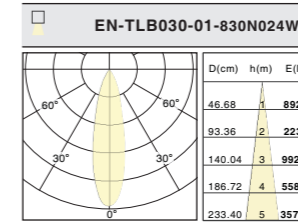
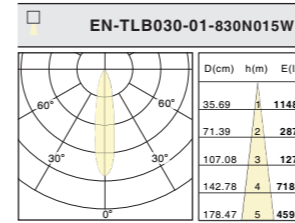

| Order info. | Power | Led Current | Luminous Flux(lm) | CRI | CCT | Beam Angle (°) |
|-----------------------|-------|-------------|-------------------|-----|-------|----------------|
| EN-TLB030-01-830N015W | 30 W | 700mA | 2643 lm | 80+ | 3000K | 15° |
| EN-TLB030-01-840N015W | 30 W | 700mA | 2782 lm | 80+ | 4000K | 15° |
| EN-TLB030-01-830N024W | 30 W | 700mA | 2640 lm | 80+ | 3000K | 24° |
| EN-TLB030-01-840N024W | 30 W | 700mA | 2779 lm | 80+ | 4000K | 24° |
| EN-TLB030-01-830N038W | 30 W | 700mA | 2632 lm | 80+ | 3000K | 38° |
| EN-TLB030-01-840N038W | 30 W | 700mA | 2770 lm | 80+ | 4000K | 38° |
| EN-TLB030-01-830N060W | 30 W | 700mA | 2605 lm | 80+ | 3000K | 60° |
| EN-TLB030-01-840N060W | 30 W | 700mA | 2742 lm | 80+ | 4000K | 60° |

Cadio Series

CADIO family is designed for lighting retail, gallery and exhibition spaces. Interchangeable beams can fulfill different light demands. CADIO is available in two versions, the driver apart from LED engine or integrated with LED engine.

CADIO compact version is a family with both track mounted and surface mounted spotlights, if you have an environment asking for different installation method, it will be possible to use the same spotlight family and get a unified impression.

Overview

| | |
|------------------------|-------------------------------|
| Application: | On track |
| Light source: | COB LED |
| SDCM: | <3 |
| Light solution: | Fixed lens 15°, 24°, 38°, 60° |
| Watt: | 20W - 30W |
| CCT: | 2700K, 3000K, 4000K, 5000K |
| CRI: | 80+, 90+ |
| Luminous: | 1974lm-2782lm |
| Control option: | On/off, Triac, DALI |
| Color: | White, Black, Silver |



STANDARD



CADIO(EN-TLC series, classic style) is designed for lighting retail, gallery and exhibition spaces. The driver compartment is separate from the optical compartment, assuring excellent thermal dissipation and a balanced design. Interchangeable beam reflector can help you to change the beam reflector easily without tools.

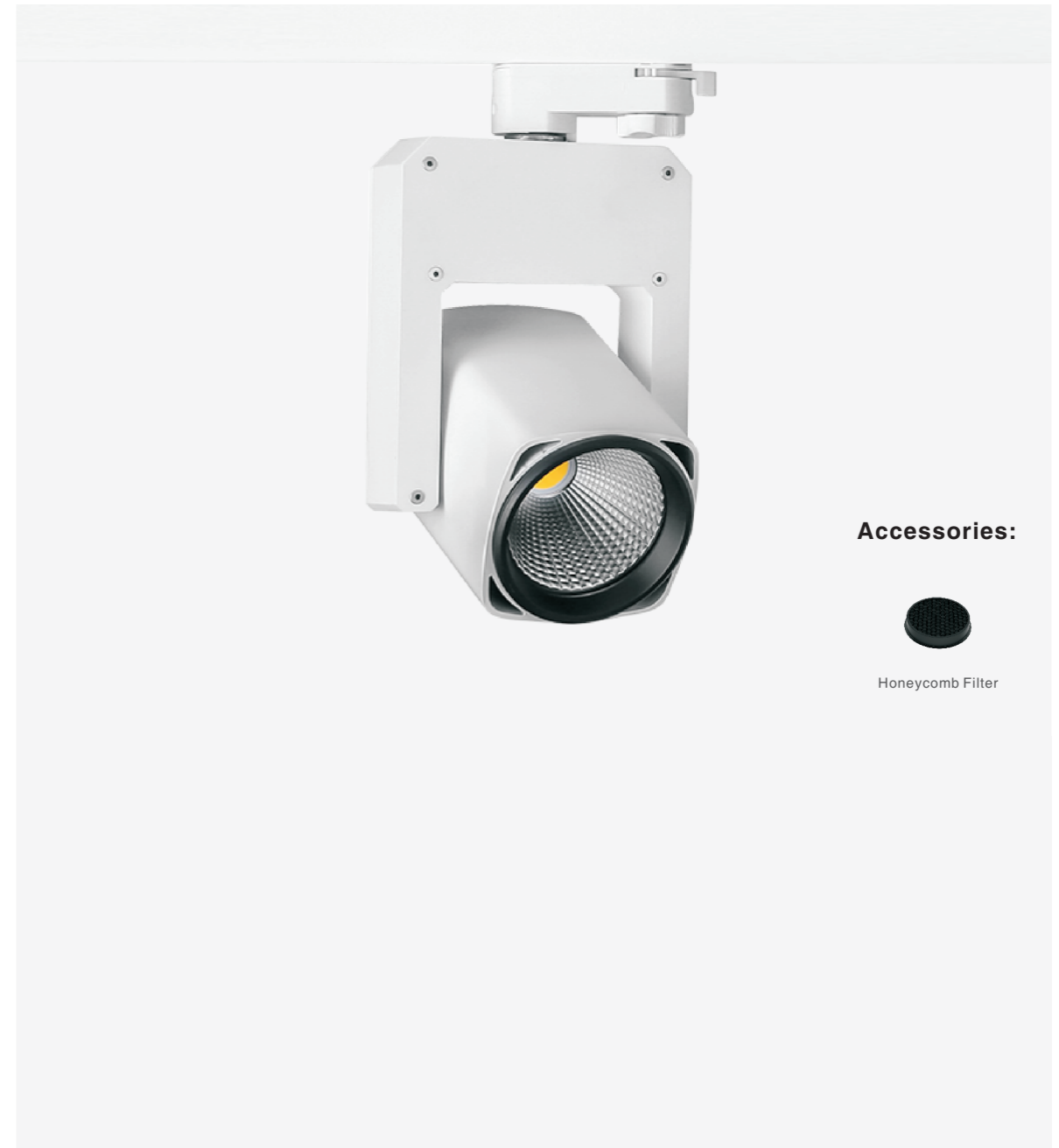

MAIN FEATURES:

- Compact design with integrated driver.
- Light efficiency is up to 90lm/W.
- Interchangeable reflector: 15°, 24°, 38°, 60°
- Privately-designed joint can hold the track head at any positions without malfunctions.
- Rotating solution: 355° in horizontal, 90° in vertical.

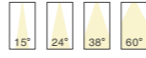
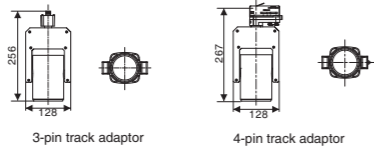

3000K

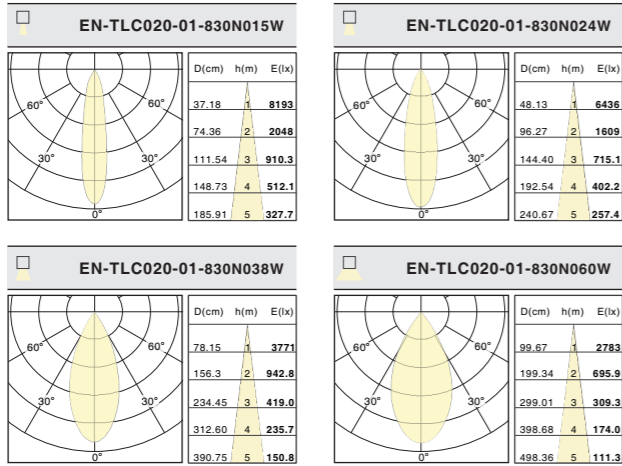

| Order info. | Power | Led Current | Luminous Flux(lm) | CRI | CCT | Beam Angle (°) |
|-----------------------|-------|-------------|-------------------|-----|-------|----------------|
| EN-TLC020-01-830N015W | 20 W | 520mA | 1974 lm | 80+ | 3000K | 15° |
| EN-TLC020-01-840N015W | 20 W | 520mA | 2077 lm | 80+ | 4000K | 15° |
| EN-TLC020-01-830N024W | 20 W | 520mA | 1980 lm | 80+ | 3000K | 24° |
| EN-TLC020-01-840N024W | 20 W | 520mA | 2084 lm | 80+ | 4000K | 24° |
| EN-TLC020-01-830N038W | 20 W | 520mA | 1974 lm | 80+ | 3000K | 38° |
| EN-TLC020-01-840N038W | 20 W | 520mA | 2078 lm | 80+ | 4000K | 38° |
| EN-TLC020-01-830N060W | 20 W | 520mA | 1981 lm | 80+ | 3000K | 60° |
| EN-TLC020-01-840N060W | 20 W | 520mA | 2085 lm | 80+ | 4000K | 60° |

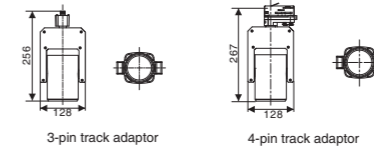

3000K

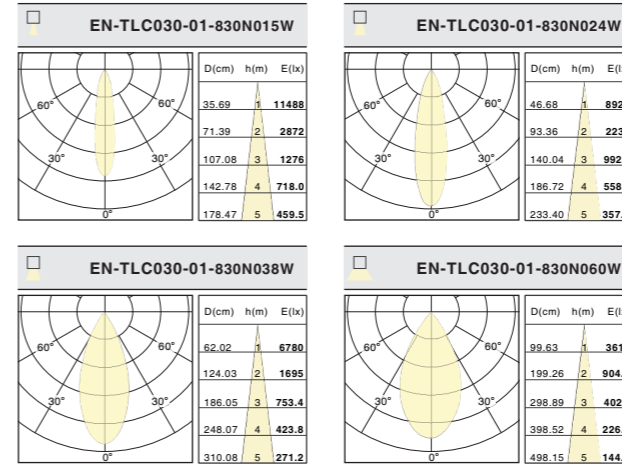

| Order info. | Power | Led Current | Luminous Flux(lm) | CRI | CCT | Beam Angle (°) |
|-----------------------|-------|-------------|-------------------|-----|-------|----------------|
| EN-TLC030-01-830N015W | 30 W | 700mA | 2643 lm | 80+ | 3000K | 15° |
| EN-TLC030-01-840N015W | 30 W | 700mA | 2782 lm | 80+ | 4000K | 15° |
| EN-TLC030-01-830N024W | 30 W | 700mA | 2640 lm | 80+ | 3000K | 24° |
| EN-TLC030-01-840N024W | 30 W | 700mA | 2779 lm | 80+ | 4000K | 24° |
| EN-TLC030-01-830N038W | 30 W | 700mA | 2632 lm | 80+ | 3000K | 38° |
| EN-TLC030-01-840N038W | 30 W | 700mA | 2770 lm | 80+ | 4000K | 38° |
| EN-TLC030-01-830N060W | 30 W | 700mA | 2605 lm | 80+ | 3000K | 60° |
| EN-TLC030-01-840N060W | 30 W | 700mA | 2742 lm | 80+ | 4000K | 60° |

PREMIUM



CADIO(EN-TLC series, compact style) LED track light is designed for lighting retail, gallery and exhibition spaces. The front snoot can bring a good light comfort. The head can be adjusted precisely 360°+ horizontal(rotation) without dead angle and 90°vertical. The light, as a result, is emitted exactly where you need it. The integrated driver gives clean feeling and the ceiling will not be cluttered with drivers aimed in different directions. Support track mount and surface mount.



MAIN FEATURES:

- Compact design with integrated driver.
- Light efficiency is up to 110lm/W.
- Interchangeable reflector: 15°, 24°, 38°, 60°
- Privately-designed joint can hold the track head at any positions without malfunctions.
- 360°+ horizontal(rotation) adjustment and 90° vertical aiming.



EN-TLC025-11

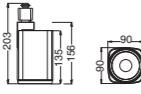

3-pin track adaptor

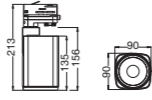

4-pin track adaptor



3000K

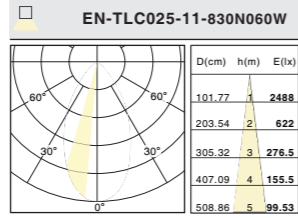
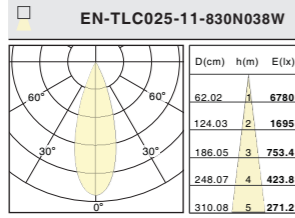
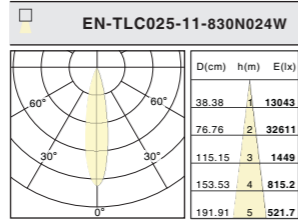
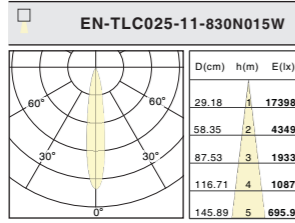

| Order info. | Power | Led Current | Luminous Flux(lm) | CRI | CCT | Beam Angle (°) |
|-----------------------|-------|-------------|-------------------|-----|-------|----------------|
| EN-TLC025-11-830N015W | 25 W | 600mA | 2521 lm | 80+ | 3000K | 15° |
| EN-TLC025-11-840N015W | 25 W | 600mA | 2653 lm | 80+ | 4000K | 15° |
| EN-TLC025-11-830N024W | 25 W | 600mA | 2697 lm | 80+ | 3000K | 24° |
| EN-TLC025-11-840N024W | 25 W | 600mA | 2839 lm | 80+ | 4000K | 24° |
| EN-TLC025-11-830N038W | 25 W | 600mA | 2574 lm | 80+ | 3000K | 38° |
| EN-TLC025-11-840N038W | 25 W | 600mA | 2709 lm | 80+ | 4000K | 38° |
| EN-TLC025-11-830N060W | 25 W | 600mA | 2303 lm | 80+ | 3000K | 60° |
| EN-TLC025-11-840N060W | 25 W | 600mA | 2425 lm | 80+ | 4000K | 60° |



ON Track
EN-TLC025-11

Surface-mounted
EN-TLC025-12

Pendant
EN-TLC025-13

Quasar Series

QUASAR(EN-TLJ series) versatility allows it to be used for both accent and general lighting applications, even from considerable heights, thanks to the use of high powered LED engines with flux up to 5600lm. A compact design with superior thermal management makes this fixture perfect for any truly High-end commercial application.

Overview

| | |
|------------------------|--|
| Application: | On track |
| Light source: | COB LED |
| SDCM: | <3 |
| Light solution: | Fixed lens 10°, 12°, 15°, 20°, 24°, 38°, 60° |
| Watt: | 8W - 50W |
| CCT: | 2700K, 3000K, 4000K, 5000K |
| CRI: | 80+, 90+ |
| Luminous: | 769lm-5760lm |
| Control option: | On/off, Triac, DALI |
| Color: | White, Black, Silver |





MAIN FEATURES:

- Compact design with integrated driver(8W, 30W).
- Light efficiency is up to 110lm/W(50W).
- Privately-designed joint can hold the track head at any positions without malfunctions.
- 360°+ rotation without dead angle and 90° vertical aiming.

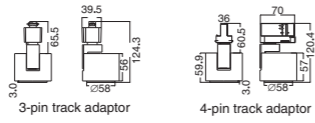

3000K

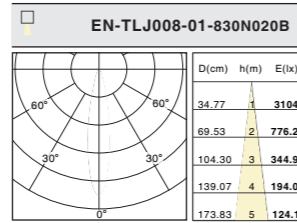
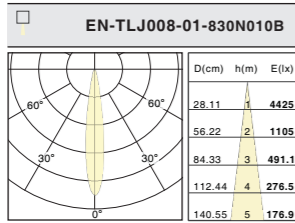

| Order info. | Power | Led Current | Luminous Flux(lm) | CRI | CCT | Beam Angle (°) |
|-----------------------|-------|-------------|-------------------|-----|-------|----------------|
| EN-TLJ008-01-830N010B | 8 W | 200mA | 770 lm | 80+ | 3000K | 10° |
| EN-TLJ008-01-840N010B | 8 W | 200mA | 811 lm | 80+ | 4000K | 10° |
| EN-TLJ008-01-830N020B | 8 W | 200mA | 770 lm | 80+ | 3000K | 20° |
| EN-TLJ008-01-840N020B | 8 W | 200mA | 769 lm | 80+ | 4000K | 20° |

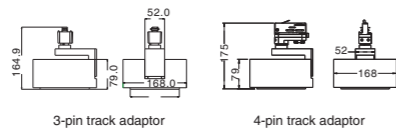

3000K

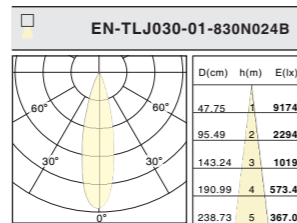
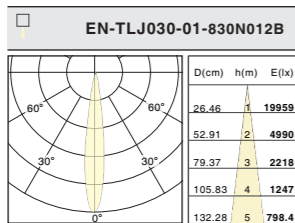

| Order info. | Power | Led Current | Luminous Flux(lm) | CRI | CCT | Beam Angle (°) |
|-----------------------|-------|-------------|-------------------|-----|-------|----------------|
| EN-TLJ030-01-830N012B | 30 W | 700mA | 2741 lm | 80+ | 3000K | 12° |
| EN-TLJ030-21-840N012B | 30 W | 700mA | 2855 lm | 80+ | 4000K | 12° |
| EN-TLJ030-01-830N024B | 30 W | 700mA | 2728 lm | 80+ | 3000K | 24° |
| EN-TLJ030-21-840N024B | 30 W | 700mA | 2841 lm | 80+ | 4000K | 24° |

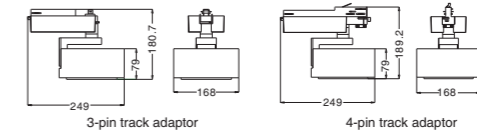

3000K

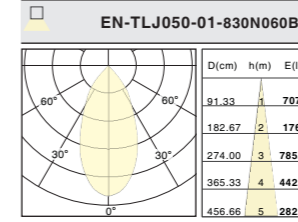
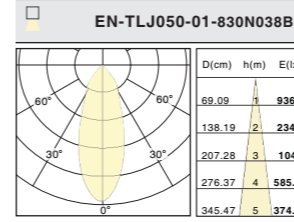
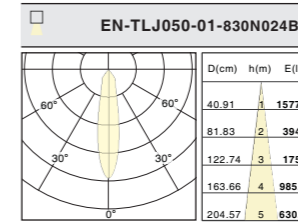
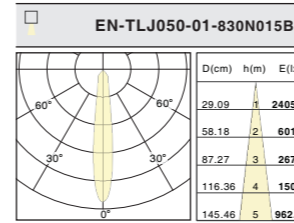

| Order info. | Power | Led Current | Luminous Flux(lm) | CRI | CCT | Beam Angle (°) |
|-----------------------|-------|-------------|-------------------|-----|-------|----------------|
| EN-TLJ050-01-830N015B | 50 W | 1200mA | 5341 lm | 80+ | 3000K | 15° |
| EN-TLJ050-01-840N015B | 50 W | 1200mA | 5564 lm | 80+ | 4000K | 15° |
| EN-TLJ050-01-830N024B | 50 W | 1200mA | 5386 lm | 80+ | 3000K | 24° |
| EN-TLJ050-01-840N024B | 50 W | 1200mA | 5610 lm | 80+ | 4000K | 24° |
| EN-TLJ050-01-830N038B | 50 W | 1200mA | 5419 lm | 80+ | 3000K | 38° |
| EN-TLJ050-01-840N038B | 50 W | 1200mA | 5645 lm | 80+ | 4000K | 38° |
| EN-TLJ050-01-830N060B | 50 W | 1200mA | 5404 lm | 80+ | 3000K | 60° |
| EN-TLJ050-01-840N060B | 50 W | 1200mA | 5630 lm | 80+ | 4000K | 60° |

Gimini Series

GEMINI(EN-TLL series) is designed for lighting retail, gallery and exhibition spaces. The driver compartment is separate from the optical compartment, assuring excellent thermal dissipation and a balanced design. Interchangeable beam reflector can help you to change the beam reflector easily without tools. GEMINI is available in two sizes with 15W version and 35W version.

Overview

| | |
|------------------------|---|
| Application: | On track |
| Light source: | COB LED |
| SDCM: | <3 |
| Light solution: | Fixed lens 10°, 15°, 18°, 24°, 30°, 38° |
| Watt: | 15W - 35W |
| CCT: | 2700K, 3000K, 4000K, 5000K |
| CRI: | 80+, 90+ |
| Luminous: | 1192lm-3192lm |
| Control option: | On/off, Triac, DALI |
| Color: | White, Black |



EN-TLL015-01

EN-TLL035-01

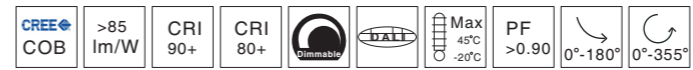
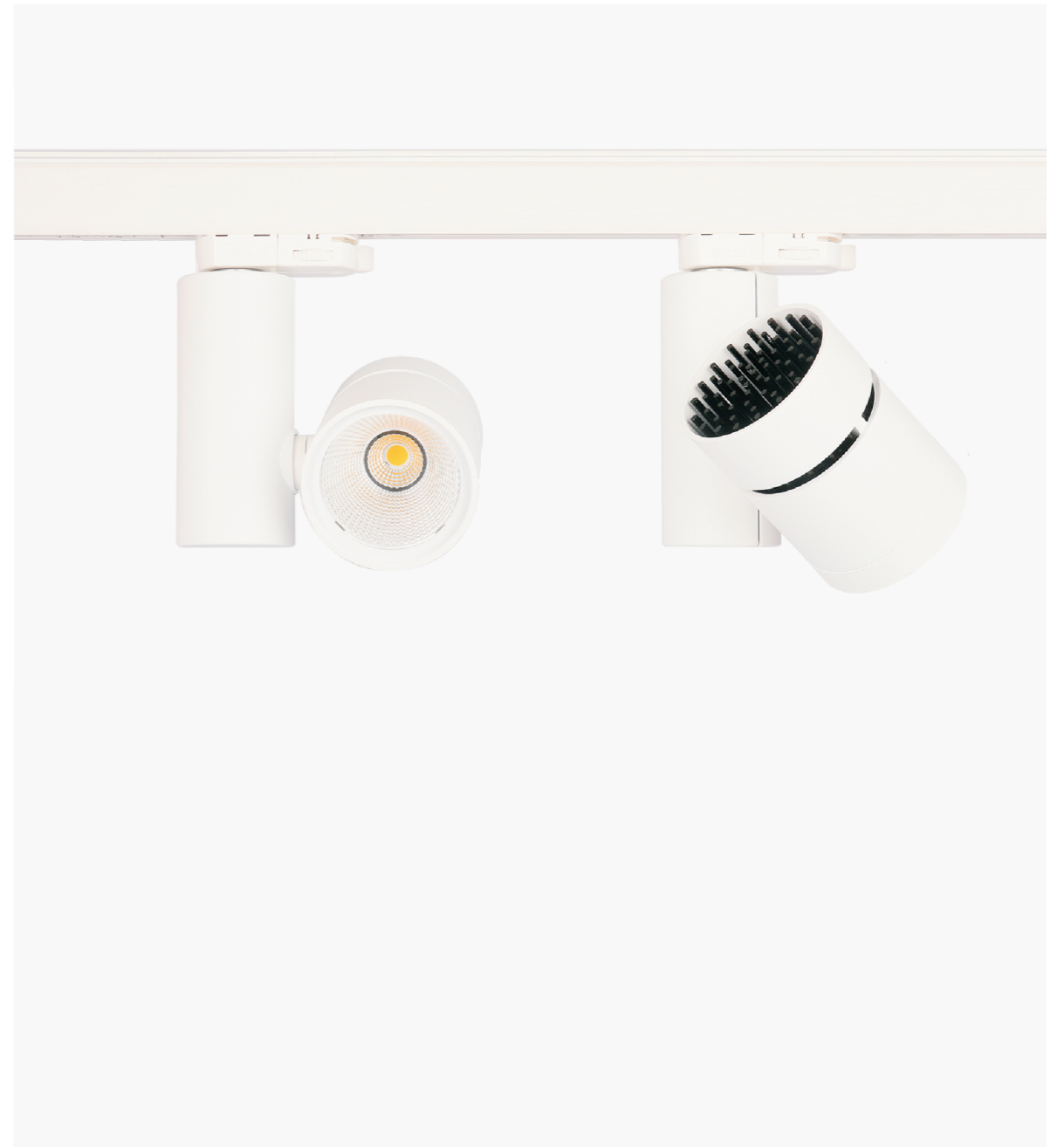

MAIN FEATURES:

- Clean & elegant design thanks to dual-cylinder perfect combination.
- Interchangeable reflector: 10°, 18°, 30°, 38°.
- Privately-designed joint can hold the track head at any positions without malfunctions.
- 355°+ rotation and 180° vertical aiming.



EN-TLL015-01

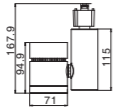

3-pin track adaptor

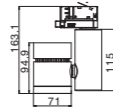

4-pin track adaptor



3000K

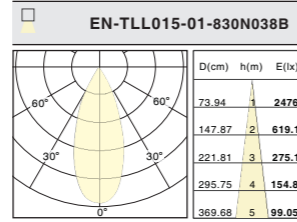
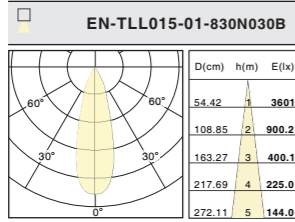
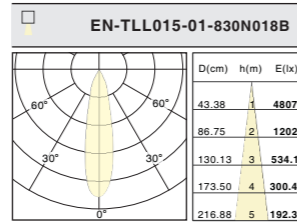
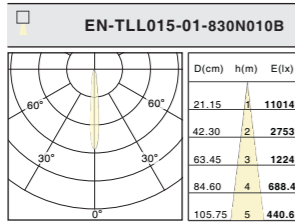

| Order info. | Power | Led Current | Luminous Flux(lm) | CRI | CCT | Beam Angle (°) |
|-----------------------|-------|-------------|-------------------|-----|-------|----------------|
| EN-TLL015-01-830N010B | 15 W | 350mA | 1291 lm | 80+ | 3000K | 10° |
| EN-TLL015-01-840N010B | 15 W | 350mA | 1359 lm | 80+ | 4000K | 10° |
| EN-TLL015-01-830N018B | 15 W | 350mA | 1272 lm | 80+ | 3000K | 18° |
| EN-TLL015-01-840N018B | 15 W | 350mA | 1338 lm | 80+ | 4000K | 18° |
| EN-TLL015-01-830N030B | 15 W | 350mA | 1269 lm | 80+ | 3000K | 30° |
| EN-TLL015-01-840N030B | 15 W | 350mA | 1336 lm | 80+ | 4000K | 30° |
| EN-TLL015-01-830N038B | 15 W | 350mA | 1192 lm | 80+ | 3000K | 38° |
| EN-TLL015-01-840N038B | 15 W | 350mA | 1255 lm | 80+ | 4000K | 38° |



EN-TLL035-01

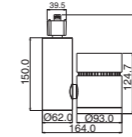

3-pin track adaptor

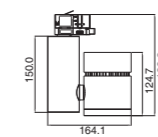

4-pin track adaptor



3000K

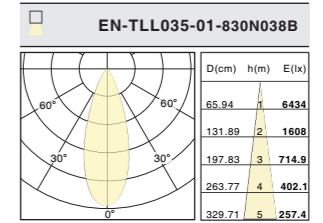
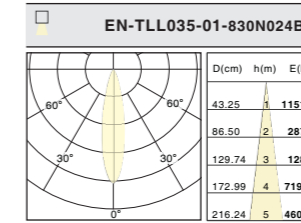
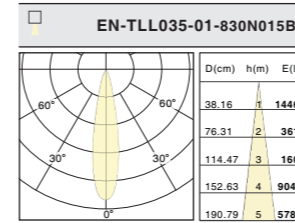

| Order info. | Power | Led Current | Luminous Flux(lm) | CRI | CCT | Beam Angle (°) |
|-----------------------|-------|-------------|-------------------|-----|-------|----------------|
| EN-TLL035-01-830N015B | 35 W | 850mA | 3026 lm | 80+ | 3000K | 15° |
| EN-TLL035-01-840N015B | 35 W | 850mA | 3185 lm | 80+ | 4000K | 15° |
| EN-TLL035-01-830N024B | 35 W | 850mA | 3032 lm | 80+ | 3000K | 24° |
| EN-TLL035-01-840N024B | 35 W | 850mA | 3192 lm | 80+ | 4000K | 24° |
| EN-TLL035-01-830N038B | 35 W | 850mA | 2994 lm | 80+ | 3000K | 38° |
| EN-TLL035-01-840N038B | 35 W | 850mA | 3151 lm | 80+ | 4000K | 38° |

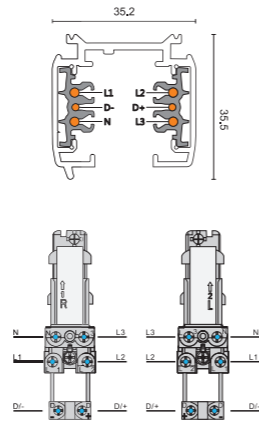
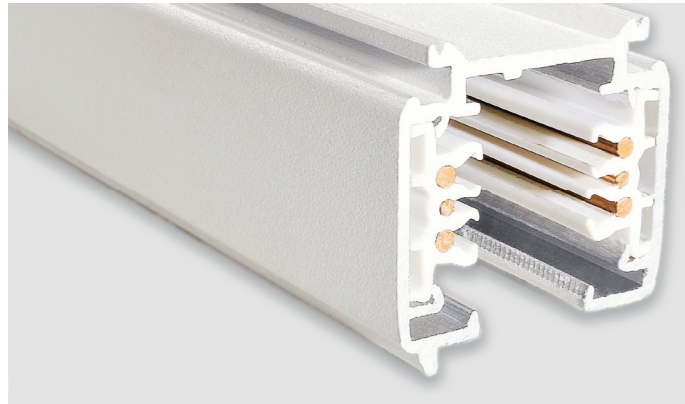

FIXING POINT DIMENSIONS

| L / mm | a / mm | b / mm | c / mm | d / mm |
|--------|--------|--------|--------|--------|
| 1000 | 125 | | | |
| 2000 | 125 | 998 | | |
| 3000 | 125 | | 914 | 1167 |
| 4000 | 125 | | 1247 | 1501 |

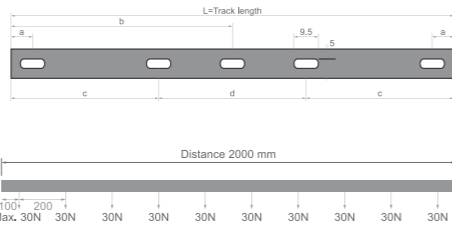

MECHANICAL LOAD DIAGRAM



| Model No | Track length | Shell Material | Colour | Package |
|---|-----------------------------------|--------------------|--------------------------|---------|
| Pro-0610-W / Pro-0610-S / Pro-0610-B | 1M track actual one meter.(100cm) | Aluminum Extrusion | White □ Silver ■ Black ■ | 1 / 12 |
| Pro-0620-W / Pro-0620-S / Pro-0620-B | 2M track actual one meter(200cm) | Aluminum Extrusion | White □ Silver ■ Black ■ | 1 / 12 |
| Pro-0630-W / Pro-0630-S / Pro-0630-B | 3M track actual one meter(300cm) | Aluminum Extrusion | White □ Silver ■ Black ■ | 1 / 8 |
| Pro-06400-W / Pro-06400-S / Pro-06400-B | 4M track actual one meter(400cm) | Aluminum Extrusion | White □ Silver ■ Black ■ | 1 / 6 |

SmartFeed

Intelligent DALI power feed integrated with wireless DALI control. The DALI track system can be controlled by iPhone or iPad Apps that we developed in-house via Bluetooth connection.

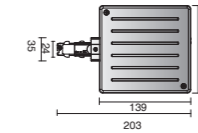

| Model No. | Colour |
|--------------|----------|
| Pro-D631SF-W | White □ |
| Pro-D631SF-S | Silver ■ |
| Pro-D631SF-B | Black ■ |

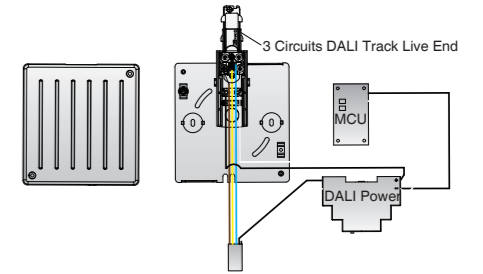

3 Circuits DALI Adaptor with 3M&5M wire

DALI track adaptor with 3 or 5 meter cable consist of AC power and DALI signal cords for various DALI lighting applications. It provides fast efficient wiring connection and simplify DALI wiring installation.

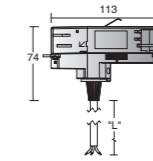

| Model No. | Model No. | Package | Colour |
|---------------|---------------|---------|----------|
| Pro-D680-3M-W | Pro-D680-5M-W | 1 / 30 | White □ |
| Pro-D680-3M-S | Pro-D680-5M-S | 1 / 30 | Silver ■ |
| Pro-D680-3M-B | Pro-D680-5M-B | 1 / 30 | Black ■ |

Application Diagram



DALI Adaptor

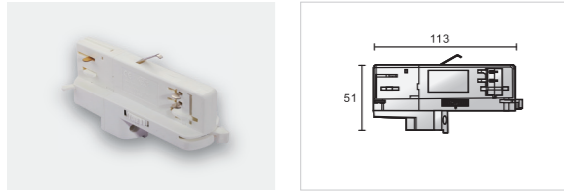

| Model No. | Package | Colour |
|------------|---------|----------|
| Pro-D680-W | 1 / 150 | White □ |
| Pro-D680-S | 1 / 150 | Silver ■ |
| Pro-D680-B | 1 / 150 | Black ■ |

End Cap

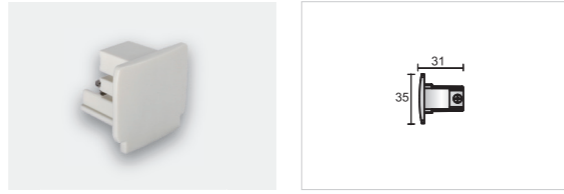

| Model No. | Package | Colour |
|------------|---------|----------|
| Pro-0432-W | 1 / 500 | White □ |
| Pro-0432-S | 1 / 500 | Silver ■ |
| Pro-0432-B | 1 / 500 | Black ■ |

Flexible Connector



| Model No. | Package | Colour |
|--------------|---------|----------|
| Pro-D639 R-W | 1 / 98 | White □ |
| Pro-D639 R-S | 1 / 98 | Silver ■ |
| Pro-D639 R-B | 1 / 98 | Black ■ |

“+” Connector



| Model No. | Package | Colour |
|------------|---------|----------|
| Pro-D637-W | 1 / 56 | White □ |
| Pro-D637-S | 1 / 56 | Silver ■ |
| Pro-D637-B | 1 / 56 | Black ■ |

Live-End Connector



| Model No. | Package | Colour |
|--------------|---------|----------|
| Pro-D631 L-W | 1 / 120 | White □ |
| Pro-D631 L-S | 1 / 120 | Silver ■ |
| Pro-D631 L-B | 1 / 120 | Black ■ |

Live-End Connector

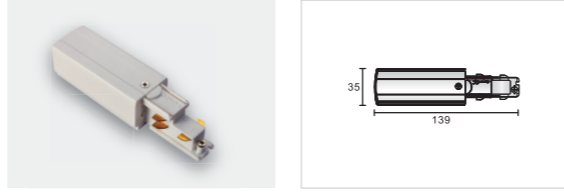

| Model No. | Package | Colour |
|--------------|---------|----------|
| Pro-D631 R-W | 1 / 120 | White □ |
| Pro-D631 R-S | 1 / 120 | Silver ■ |
| Pro-D631 R-B | 1 / 120 | Black ■ |

“T” Connector



| Model No. | Package | Colour |
|---------------|---------|----------|
| Pro-D636 L1-W | 1 / 63 | White □ |
| Pro-D636 L1-S | 1 / 63 | Silver ■ |
| Pro-D636 L1-B | 1 / 63 | Black ■ |

“T” Connector

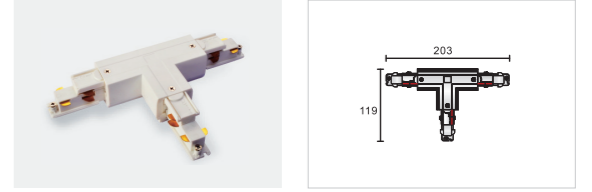

| Model No. | Package | Colour |
|---------------|---------|----------|
| Pro-D636 L2-W | 1 / 63 | White □ |
| Pro-D636 L2-S | 1 / 63 | Silver ■ |
| Pro-D636 L2-B | 1 / 63 | Black ■ |

Mini Joiner

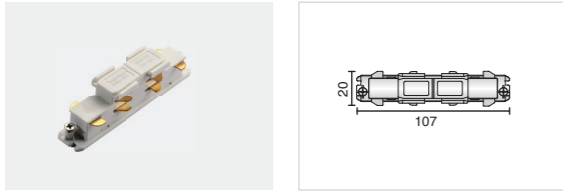

| Model No. | Package | Colour |
|------------|---------|----------|
| Pro-D633-W | 1 / 300 | White □ |
| Pro-D633-S | 1 / 300 | Silver ■ |
| Pro-D633-B | 1 / 300 | Black ■ |

Middle Connector

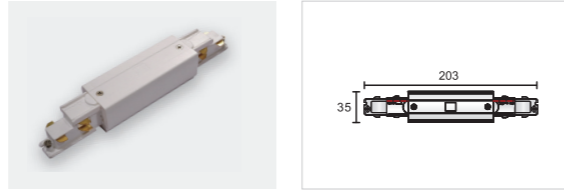

| Model No. | Package | Colour |
|------------|---------|----------|
| Pro-D634-W | 1 / 140 | White □ |
| Pro-D634-S | 1 / 140 | Silver ■ |
| Pro-D634-B | 1 / 140 | Black ■ |

“T” Connector



| Model No. | Package | Colour |
|---------------|---------|----------|
| Pro-D636 R1-W | 1 / 63 | White □ |
| Pro-D636 R1-S | 1 / 63 | Silver ■ |
| Pro-D636 R1-B | 1 / 63 | Black ■ |

“T” Connector

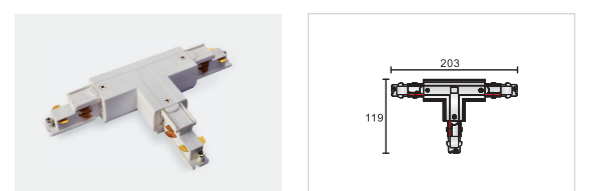

| Model No. | Package | Colour |
|---------------|---------|----------|
| Pro-D636 R2-W | 1 / 63 | White □ |
| Pro-D636 R2-S | 1 / 63 | Silver ■ |
| Pro-D636 R2-B | 1 / 63 | Black ■ |

“L” Connector



| Model No. | Package | Colour |
|--------------|---------|----------|
| Pro-D635 L-W | 1 / 112 | White □ |
| Pro-D635 L-S | 1 / 112 | Silver ■ |
| Pro-D635 L-B | 1 / 112 | Black ■ |

“L” Connector



| Model No. | Package | Colour |
|--------------|---------|----------|
| Pro-D635 R-W | 1 / 112 | White □ |
| Pro-D635 R-S | 1 / 112 | Silver ■ |
| Pro-D635 R-B | 1 / 112 | Black ■ |

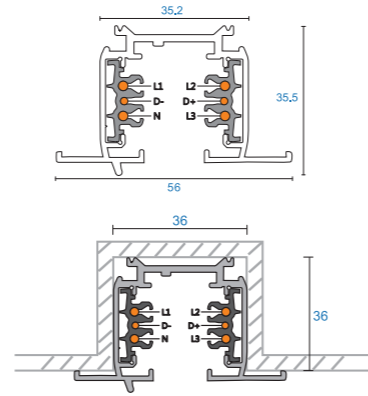
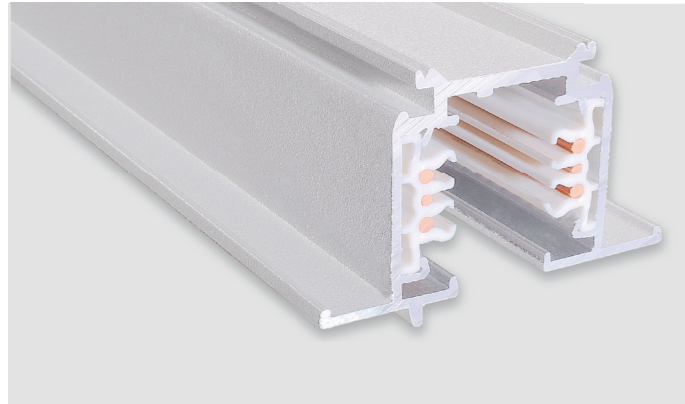

| Model No | Track length | Shell Material | Colour | Package |
|---|-----------------------------------|--------------------|--------------------------|---------|
| Pro-0610-W / Pro-0610-S / Pro-0610-B | 1M track actual one meter.(100cm) | Aluminum Extrusion | White □ Silver ■ Black ■ | 1 / 9 |
| Pro-0620-W / Pro-0620-S / Pro-0620-B | 2M track actual one meter(200cm) | Aluminum Extrusion | White □ Silver ■ Black ■ | 1 / 9 |
| Pro-0630-W / Pro-0630-S / Pro-0630-B | 3M track actual one meter(300cm) | Aluminum Extrusion | White □ Silver ■ Black ■ | 1 / 9 |
| Pro-06400-W / Pro-06400-S / Pro-06400-B | 4M track actual one meter(400cm) | Aluminum Extrusion | White □ Silver ■ Black ■ | 1 / 9 |

Middle Connector Cover

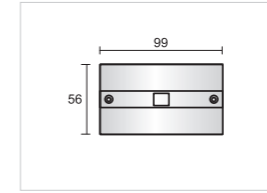

| Model No. | Package | Colour |
|------------|---------|----------|
| Pro-R434-W | 1 / 400 | White □ |
| Pro-R434-S | 1 / 400 | Silver ■ |
| Pro-R434-B | 1 / 400 | Black ■ |

“T” Connector Cover

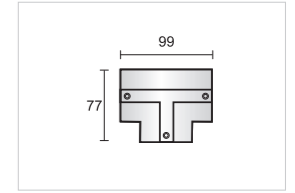
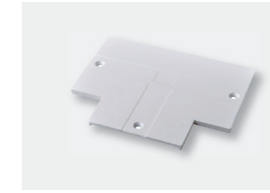

| Model No. | Package | Colour |
|------------|---------|----------|
| Pro-R436-W | 1 / 400 | White □ |
| Pro-R436-S | 1 / 400 | Silver ■ |
| Pro-R436-B | 1 / 400 | Black ■ |

Live-end Connector Cover

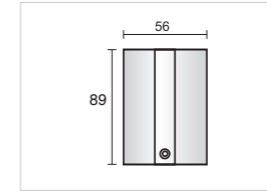

| Model No. | Package | Colour |
|------------|---------|----------|
| Pro-R631-W | 1 / 400 | White □ |
| Pro-R631-S | 1 / 400 | Silver ■ |
| Pro-R631-B | 1 / 400 | Black ■ |

“L” Connector Cover

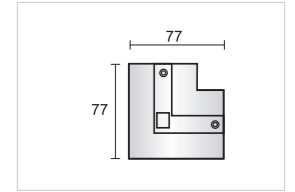

| Model No. | Package | Colour |
|------------|---------|----------|
| Pro-R435-W | 1 / 400 | White □ |
| Pro-R435-S | 1 / 400 | Silver ■ |
| Pro-R435-B | 1 / 400 | Black ■ |

“+” Connector Cover

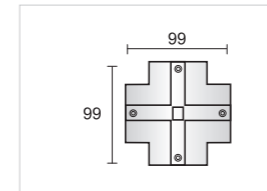

| Model No. | Package | Colour |
|------------|---------|----------|
| Pro-R437-W | 1 / 400 | White □ |
| Pro-R437-S | 1 / 400 | Silver ■ |
| Pro-R437-B | 1 / 400 | Black ■ |

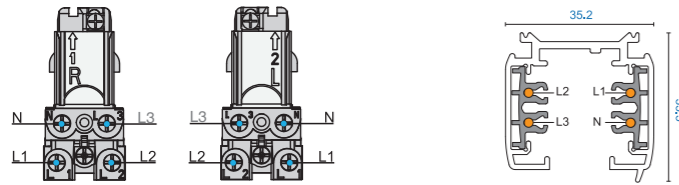

| Model No. | Track length | Shell Material | Colour | Package |
|---|-----------------------------------|--------------------|--------------------------|---------|
| Pro-0410-W / Pro-0410-S / Pro-0410-B | 1M track actual one meter.(100cm) | Aluminum Extrusion | White □ Silver ■ Black ■ | 1 / 12 |
| Pro-0420-W / Pro-0420-S / Pro-0420-B | 2M track actual one meter.(200cm) | Aluminum Extrusion | White □ Silver ■ Black ■ | 1 / 12 |
| Pro-0430-W / Pro-0430-S / Pro-0430-B | 3M track actual one meter.(300cm) | Aluminum Extrusion | White □ Silver ■ Black ■ | 1 / 8 |
| Pro-04400-W / Pro-04400-S / Pro-04400-B | 4M track actual one meter.(400cm) | Aluminum Extrusion | White □ Silver ■ Black ■ | 1 / 6 |

3 Circuits Adaptor- ULTRA SLIM



| Model No. | Package | Colour |
|-------------|---------|----------|
| Pro-0440S-W | 1 / 150 | White □ |
| Pro-0440S-S | 1 / 150 | Silver ■ |
| Pro-0440S-B | 1 / 150 | Black ■ |

3 Circuits Adaptor- SMART

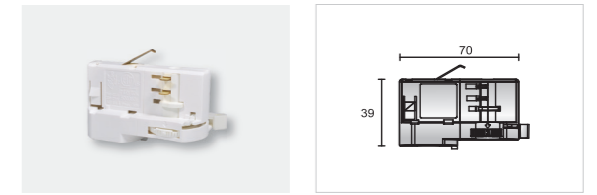

| Model No. | Package | Colour |
|------------|---------|----------|
| Pro-0222-W | 1 / 150 | White □ |
| Pro-0222-S | 1 / 150 | Silver ■ |
| Pro-0222-B | 1 / 150 | Black ■ |

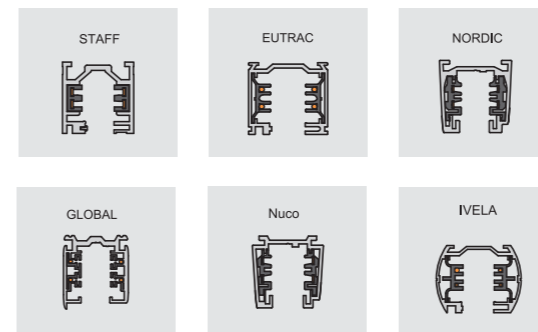

3 circuits track adaptor is universal compatible.
It will work with the following brand track:
GLOBAL, EUTRAC AND OTHER BRANDS
ONE PART ADAPT IT ALL!

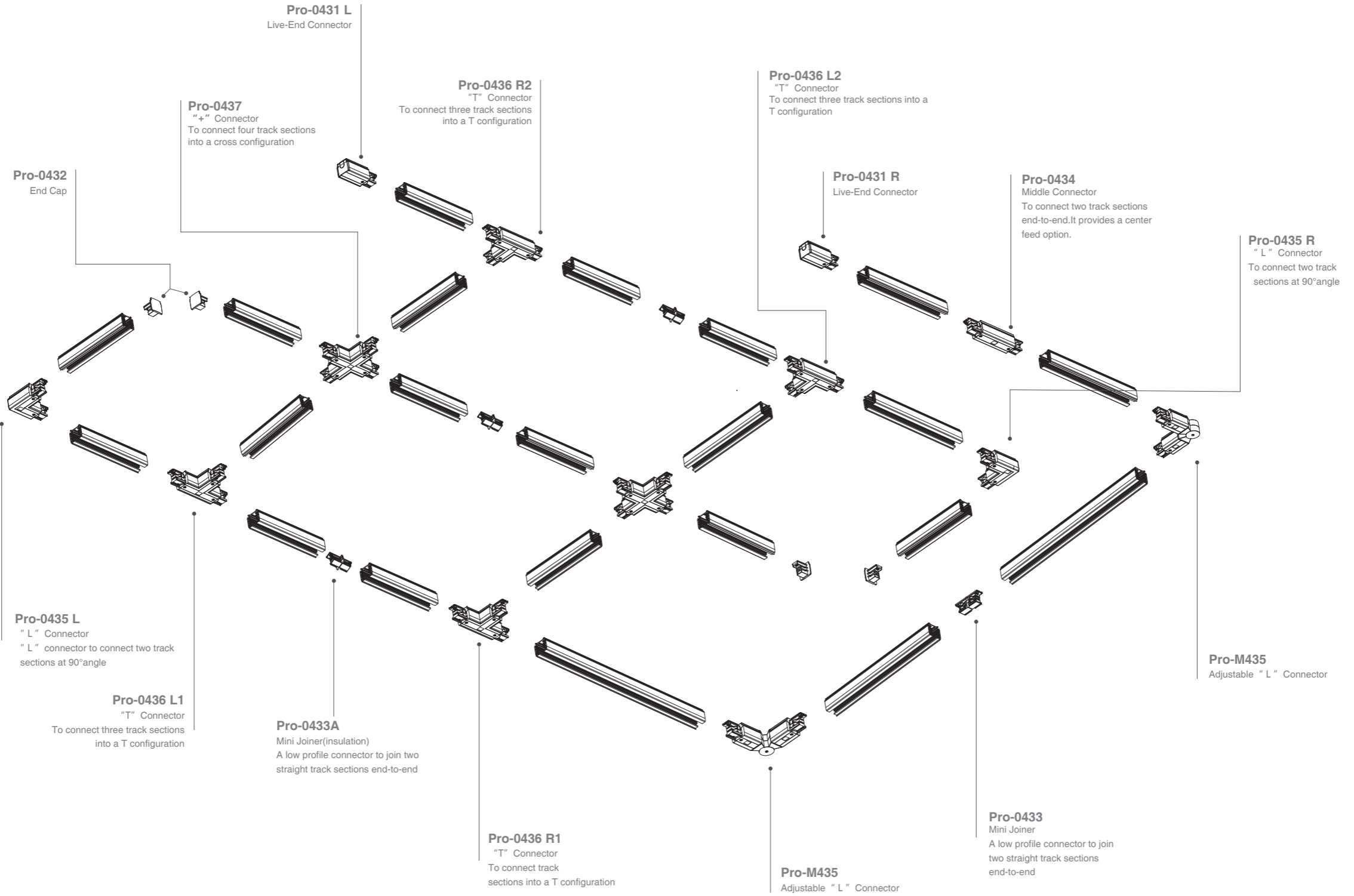

Live-End Connector

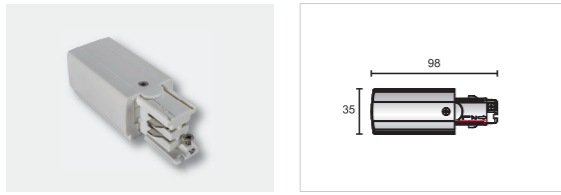

| Model No. | Package | Colour |
|--------------|---------|----------|
| Pro-0431 L-W | 1 / 150 | White □ |
| Pro-0431 L-S | 1 / 150 | Silver ■ |
| Pro-0431 L-B | 1 / 150 | Black ■ |

Live-End Connector



| Model No. | Package | Colour |
|--------------|---------|----------|
| Pro-0431 R-W | 1 / 150 | White □ |
| Pro-0431 R-S | 1 / 150 | Silver ■ |
| Pro-0431 R-B | 1 / 150 | Black ■ |

“L” Connector

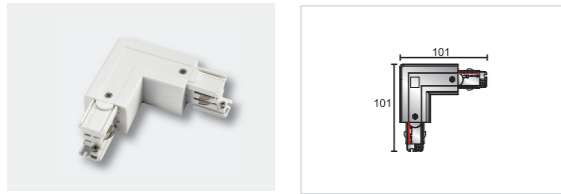

| Model No. | Package | Colour |
|--------------|---------|----------|
| Pro-0435 L-W | 1 / 154 | White □ |
| Pro-0435 L-S | 1 / 154 | Silver ■ |
| Pro-0435 L-B | 1 / 154 | Black ■ |

“L” Connector

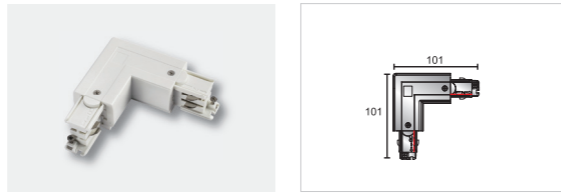

| Model No. | Package | Colour |
|--------------|---------|----------|
| Pro-0435 R-W | 1 / 154 | White □ |
| Pro-0435 R-S | 1 / 154 | Silver ■ |
| Pro-0435 R-B | 1 / 154 | Black ■ |

Mini Joiner



| Model No. | Package | Colour |
|------------|---------|----------|
| Pro-0433-W | 1 / 400 | White □ |
| Pro-0433-S | 1 / 400 | Silver ■ |
| Pro-0433-B | 1 / 400 | Black ■ |

Mini Joiner (insulation)



| Model No. | Package | Colour |
|-------------|---------|----------|
| Pro-0433A-W | 1 / 400 | White □ |
| Pro-0433A-S | 1 / 400 | Silver ■ |
| Pro-0433A-B | 1 / 400 | Black ■ |

End Cap

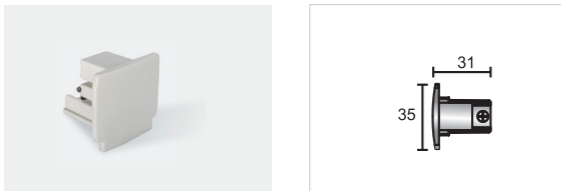

| Model No. | Package | Colour |
|------------|---------|----------|
| Pro-0432-W | 1 / 500 | White □ |
| Pro-0432-S | 1 / 500 | Silver ■ |
| Pro-0432-B | 1 / 500 | Black ■ |

Middle Connector

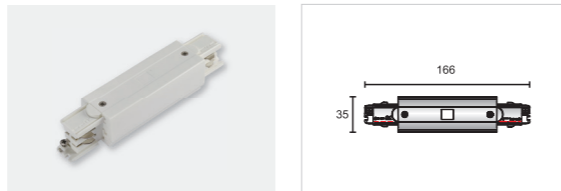

| Model No. | Package | Colour |
|------------|---------|----------|
| Pro-0434-W | 1 / 165 | White □ |
| Pro-0434-S | 1 / 165 | Silver ■ |
| Pro-0434-B | 1 / 165 | Black ■ |

“T” Connector



| Model No. | Package | Colour |
|---------------|---------|----------|
| Pro-0436 L1-W | 1 / 84 | White □ |
| Pro-0436 L1-S | 1 / 84 | Silver ■ |
| Pro-0436 L1-B | 1 / 84 | Black ■ |

“T” Connector

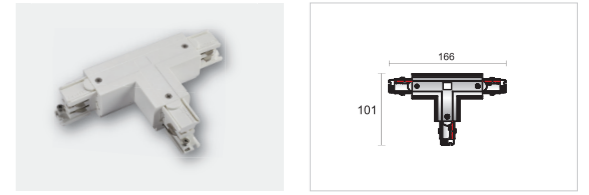

| Model No. | Package | Colour |
|---------------|---------|----------|
| Pro-0436 L2-W | 1 / 84 | White □ |
| Pro-0436 L2-S | 1 / 84 | Silver ■ |
| Pro-0436 L2-B | 1 / 84 | Black ■ |

Twisted “L” Connector

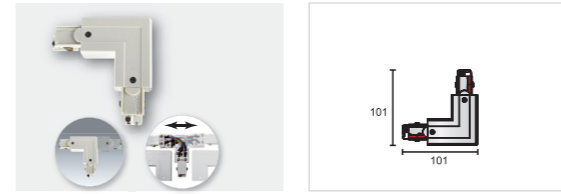

| Model No. | Package | Colour |
|------------|---------|----------|
| Pro-M438-W | 1 / 154 | White □ |
| Pro-M438-S | 1 / 154 | Silver ■ |
| Pro-M438-B | 1 / 154 | Black ■ |

“+” Connector

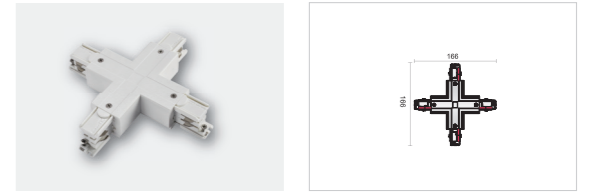

| Model No. | Package | Colour |
|------------|---------|----------|
| Pro-0437-W | 1 / 60 | White □ |
| Pro-0437-S | 1 / 60 | Silver ■ |
| Pro-0437-B | 1 / 60 | Black ■ |

“T” Connector



| Model No. | Package | Colour |
|---------------|---------|----------|
| Pro-0436 R1-W | 1 / 84 | White □ |
| Pro-0436 R1-S | 1 / 84 | Silver ■ |
| Pro-0436 R1-B | 1 / 84 | Black ■ |

“T” Connector



| Model No. | Package | Colour |
|---------------|---------|----------|
| Pro-0436 R2-W | 1 / 84 | White □ |
| Pro-0436 R2-S | 1 / 84 | Silver ■ |
| Pro-0436 R2-B | 1 / 84 | Black ■ |

Flexible Connector



| Model No. | Package | Colour |
|------------|---------|----------|
| Pro-0439-W | 1 / 119 | White □ |
| Pro-0439-S | 1 / 119 | Silver ■ |
| Pro-0439-B | 1 / 119 | Black ■ |

Adjustable “L” Connector

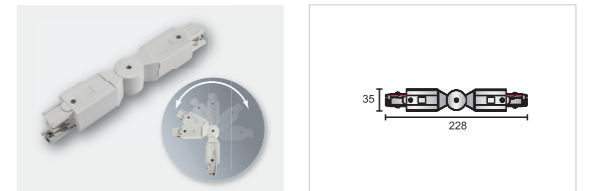

| Model No. | Package | Colour |
|------------|---------|----------|
| Pro-M435-W | 1 / 119 | White □ |
| Pro-M435-S | 1 / 119 | Silver ■ |
| Pro-M435-B | 1 / 119 | Black ■ |

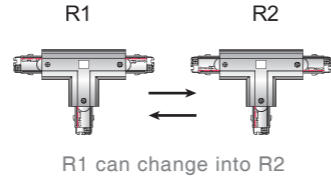
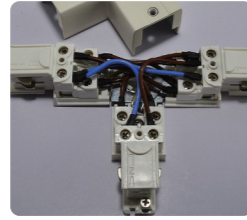
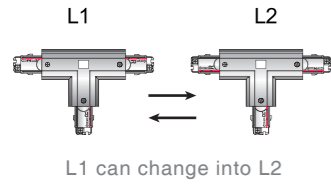

Twisted " L " Connector

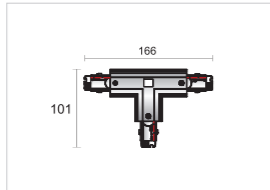

| Model No. | Package | Colour |
|--------------|---------|----------|
| Pro-M436 L-W | 1 / 84 | White □ |
| Pro-M436 L-S | 1 / 84 | Silver ■ |
| Pro-M436 L-B | 1 / 84 | Black ■ |

Twisted " L " Connector

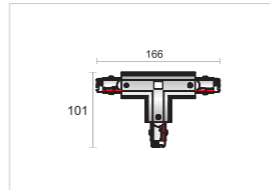

| Model No. | Package | Colour |
|--------------|---------|----------|
| Pro-M436 R-W | 1 / 84 | White □ |
| Pro-M436 R-S | 1 / 84 | Silver ■ |
| Pro-M436 R-B | 1 / 84 | Black ■ |

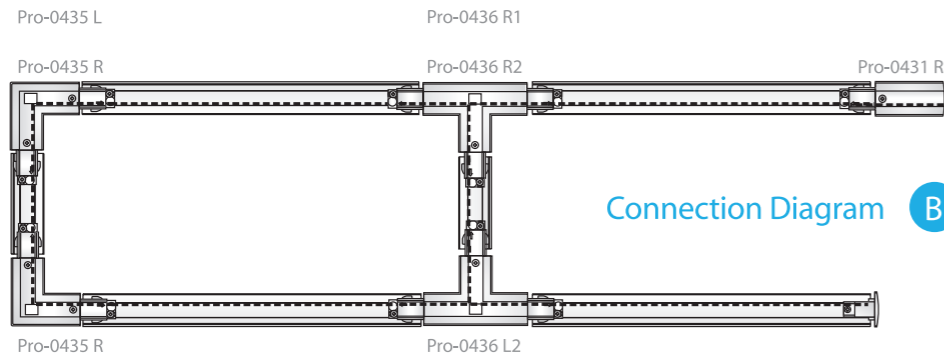
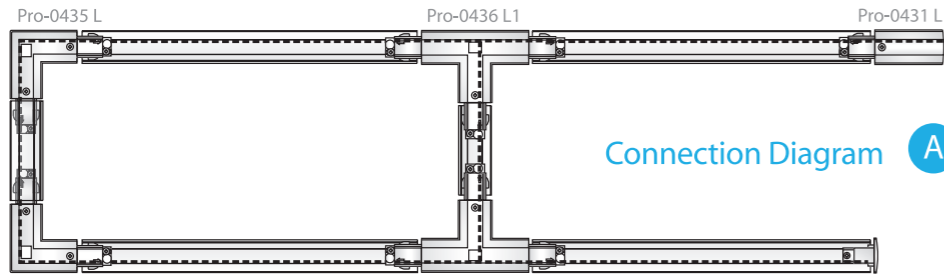

Ceiling mount, EZCLIK
suspension kit with ROD

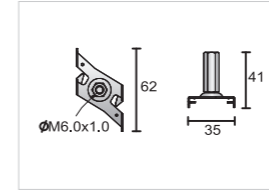
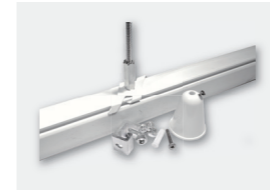

| Model No. | Package | Colour |
|--------------|---------|----------|
| Pro-EZ0447-W | 1 / 200 | White □ |
| Pro-EZ0447-S | 1 / 200 | Silver ■ |
| Pro-EZ0447-B | 1 / 200 | Black ■ |

Ceiling mount, EZCLIK
suspension kit with wire

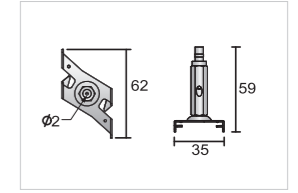
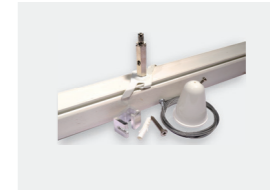

| Model No. | Package | Colour |
|--------------|---------|----------|
| Pro-EZ0448-W | 1 / 200 | White □ |
| Pro-EZ0448-S | 1 / 200 | Silver ■ |
| Pro-EZ0448-B | 1 / 200 | Black ■ |

T-Bar, EZCLIK
mounting kit

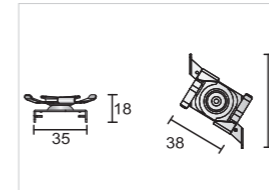

| Model No. | Package | Colour |
|-------------|---------|----------|
| Pro-M146T-W | 1 / 500 | White □ |
| Pro-M146T-S | 1 / 500 | Silver ■ |
| Pro-M146T-B | 1 / 500 | Black ■ |

Suspension Mounting
Kits Manual

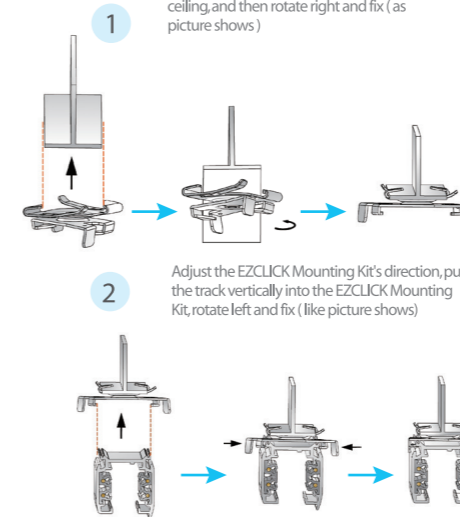

Ceiling mount,
Reinforcement Plate with suspension wire

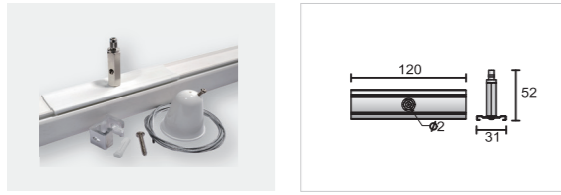

| Model No. | Package | Colour |
|------------|---------|----------|
| Pro-M147-W | 1 / 200 | White □ |
| Pro-M147-S | 1 / 200 | Silver ■ |
| Pro-M147-B | 1 / 200 | Black ■ |

Ceiling mount,
Reinforcement Plate with suspension rod



| Model No. | Package | Colour |
|------------|---------|----------|
| Pro-M148-W | 1 / 200 | White □ |
| Pro-M148-S | 1 / 200 | Silver ■ |
| Pro-M148-B | 1 / 200 | Black ■ |

Suspension Clamp for track connection

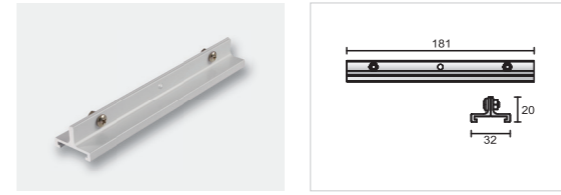

| Model No. | Package | Colour |
|---------------|---------|----------|
| Pro-0418 SK-W | 1 / 100 | White □ |
| Pro-0418 SK-S | 1 / 100 | Silver ■ |
| Pro-0418 SK-B | 1 / 100 | Black ■ |

Suspension Hook



| Model No. | Package | Colour |
|------------|---------|----------|
| Pro-M142-W | 1 / 500 | White □ |
| Pro-M142-S | 1 / 500 | Silver ■ |
| Pro-M142-B | 1 / 500 | Black ■ |

Suspension Mounting Kits Manual

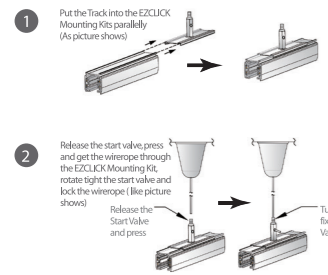

Suspension Mounting Kits Manual

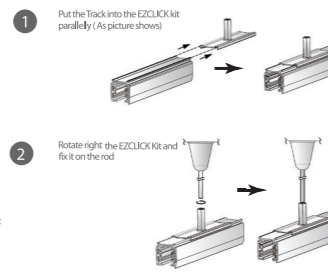

T-Bar, EZCLIK
with Reinforcement Plate

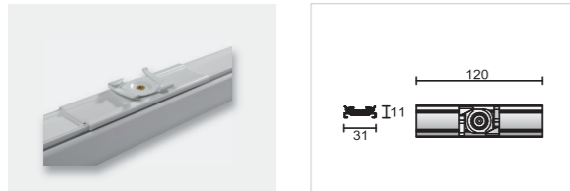

| Model No. | Package | Colour |
|------------|---------|----------|
| Pro-M149-W | 1 / 200 | White □ |
| Pro-M149-S | 1 / 200 | Silver ■ |
| Pro-M149-B | 1 / 200 | Black ■ |

Suspension Mounting Kits Manual

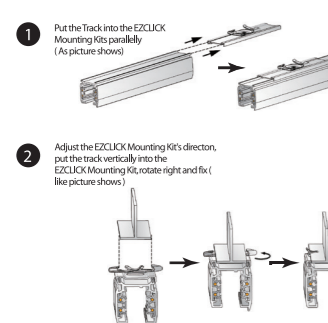

Mechanical adaptor

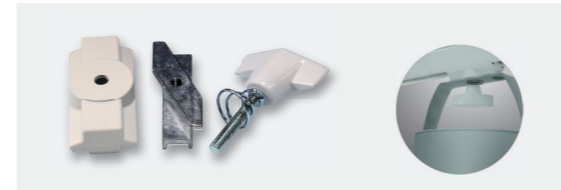

| Model No. | Package | Colour |
|------------|---------|----------|
| Pro-0449-W | 1 / 100 | White □ |
| Pro-0449-S | 1 / 100 | Silver ■ |
| Pro-0449-B | 1 / 100 | Black ■ |

Suspension kit



| Model No. | Package | Colour |
|------------|---------|----------|
| Pro-04SK-W | 1 / 100 | White □ |
| Pro-04SK-S | 1 / 100 | Silver ■ |
| Pro-04SK-B | 1 / 100 | Black ■ |

Fixed Monopoint Track Adapter



| Model No. | Package | Colour |
|------------|---------|----------|
| Pro-C100-W | 1 / 50 | White □ |
| Pro-C100-S | 1 / 50 | Silver ■ |
| Pro-C100-B | 1 / 50 | Black ■ |

Euro-trac mount electrical outlet

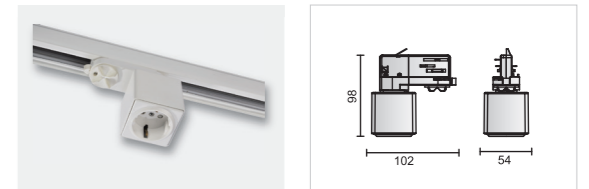

| Model No. | Package | Colour |
|-------------|---------|---------|
| Pro-4230V-W | 1 / 50 | White □ |
| Pro-4230V-B | 1 / 50 | Black ■ |



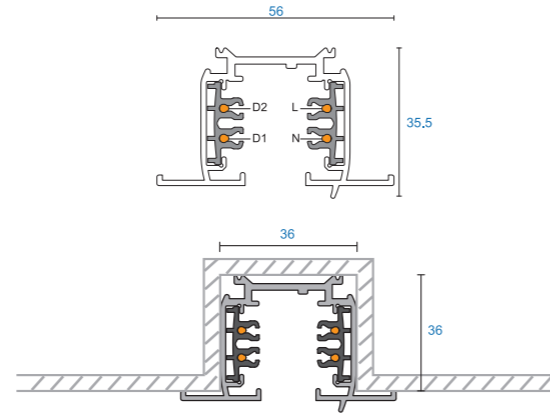
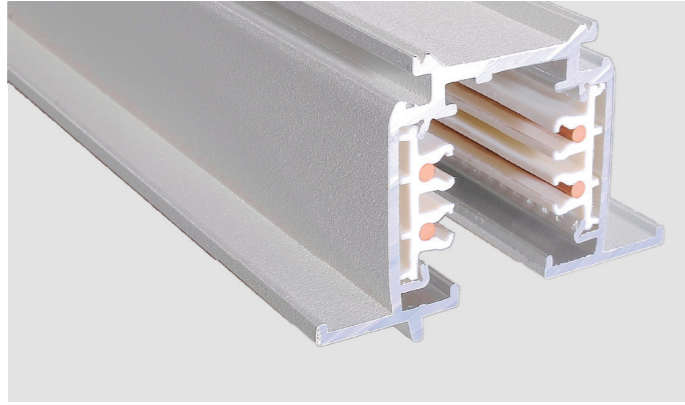

| Model No. | Track length | Shell Material | Colour | Package |
|---|-----------------------------------|--------------------|--------------------------|---------|
| Pro-R410-W / Pro-R410-S / Pro-R410-B | 1M track actual one meter.(100cm) | Aluminum Extrusion | White □ Silver ■ Black ■ | 1 / 9 |
| Pro-R420-W / Pro-R420-S / Pro-R420-B | 2M track actual one meter.(200cm) | Aluminum Extrusion | White □ Silver ■ Black ■ | 1 / 9 |
| Pro-R430-W / Pro-R430-S / Pro-R430-B | 3M track actual one meter.(300cm) | Aluminum Extrusion | White □ Silver ■ Black ■ | 1 / 6 |
| Pro-R4400-W / Pro-R4400-S / Pro-R4400-B | 4M track actual one meter.(400cm) | Aluminum Extrusion | White □ Silver ■ Black ■ | 1 / 6 |

Live-end Connector Cover

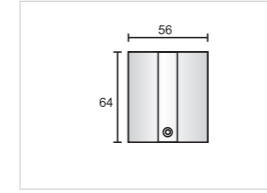

| Model No. | Package | Colour |
|------------|---------|----------|
| Pro-R431-W | 1 / 500 | White □ |
| Pro-R431-S | 1 / 500 | Silver ■ |
| Pro-R431-B | 1 / 500 | Black ■ |

Middle Connector Cover

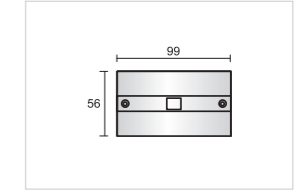

| Model No. | Package | Colour |
|------------|---------|----------|
| Pro-R434-W | 1 / 400 | White □ |
| Pro-R434-S | 1 / 400 | Silver ■ |
| Pro-R434-B | 1 / 400 | Black ■ |

“L” Connector Cover

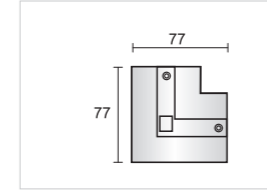

| Model No. | Package | Colour |
|------------|---------|----------|
| Pro-R435-W | 1 / 400 | White □ |
| Pro-R435-S | 1 / 400 | Silver ■ |
| Pro-R435-B | 1 / 400 | Black ■ |

“T” Connector Cover

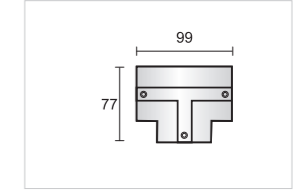
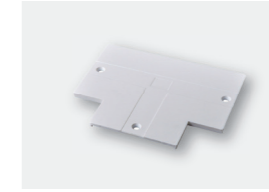

| Model No. | Package | Colour |
|------------|---------|----------|
| Pro-R436-W | 1 / 400 | White □ |
| Pro-R436-S | 1 / 400 | Silver ■ |
| Pro-R436-B | 1 / 400 | Black ■ |

“+” Connector Cover

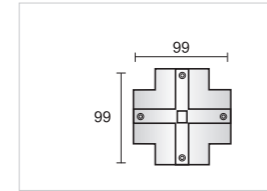
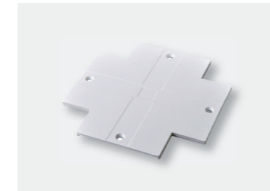

| Model No. | Package | Colour |
|------------|---------|----------|
| Pro-R437-W | 1 / 400 | White □ |
| Pro-R437-S | 1 / 400 | Silver ■ |
| Pro-R437-B | 1 / 400 | Black ■ |

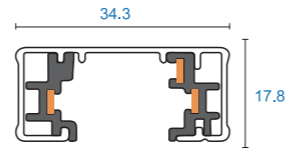
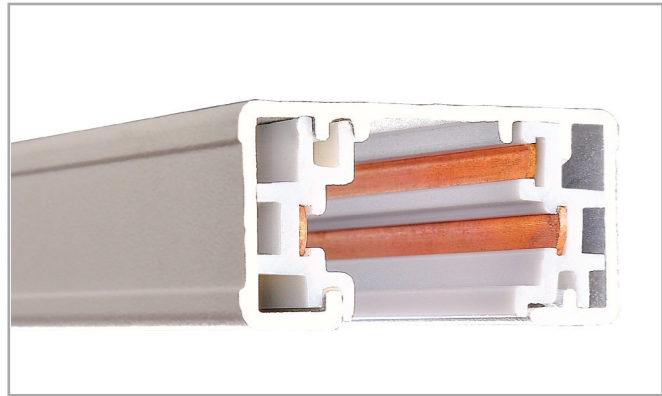

| Model No. | Track length | Shell Material | Colour | Package |
|------------|--|--------------------|--------------------------|---------|
| Pro-0310A | 1M track with double end cap.(100cm) | Aluminum Extrusion | White □ Silver ■ Black ■ | 1 / 12 |
| Pro-0320A | 2M track with double end cap.(200cm) | Aluminum Extrusion | White □ Silver ■ Black ■ | 1 / 12 |
| Pro-0330A | 3M track with double end cap.(300cm) | Aluminum Extrusion | White □ Silver ■ Black ■ | 1 / 9 |
| Pro-03400A | 4M track with double end cap.(400cm) | Aluminum Extrusion | White □ Silver ■ Black ■ | 1 / 9 |
| Pro-0302A | 2'track with double end cap actual length24" | Aluminum Extrusion | White □ Silver ■ Black ■ | 1 / 12 |
| Pro-0304A | 4'track with double end cap actual length48" | Aluminum Extrusion | White □ Silver ■ Black ■ | 1 / 12 |
| Pro-0306A | 6'track with double end cap actual length72" | Aluminum Extrusion | White □ Silver ■ Black ■ | 1 / 12 |
| Pro-0308A | 8'track with double end cap actual length96" | Aluminum Extrusion | White □ Silver ■ Black ■ | 1 / 12 |

3 wires adaptor Halo compatible



| Model No. | Package | Colour |
|-------------|---------|----------|
| Pro-A340S-W | 1 / 150 | White □ |
| Pro-A340S-S | 1 / 150 | Silver ■ |
| Pro-A340S-B | 1 / 150 | Black ■ |

3 wires adaptor Halo compatible



| Model No. | Package | Colour |
|-------------|---------|----------|
| Pro-0340S-W | 1 / 150 | White □ |
| Pro-0340S-S | 1 / 150 | Silver ■ |
| Pro-0340S-B | 1 / 150 | Black ■ |

3 wires adaptor Halo compatible



| Model No. | Package | Colour |
|------------|---------|----------|
| Pro-0340-W | 1 / 350 | White □ |
| Pro-0340-S | 1 / 350 | Silver ■ |
| Pro-0340-B | 1 / 350 | Black ■ |

3 wires adaptor Halo compatible



| Model No. | Package | Colour |
|-------------|---------|----------|
| Pro-0340L-W | 1 / 150 | White □ |
| Pro-0340L-S | 1 / 150 | Silver ■ |
| Pro-0340L-B | 1 / 150 | Black ■ |

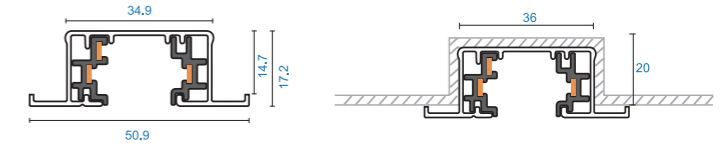
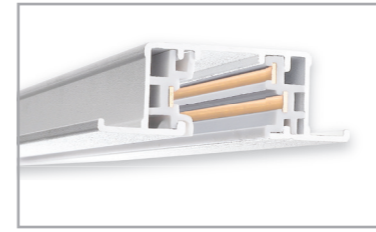

| Model No. | Track length | Shell Material | Colour | Package |
|------------|--|--------------------|--------------------------|---------|
| Pro-R310A | 1M track with double end cap.(100cm) | Aluminum Extrusion | White □ Silver ■ Black ■ | 1 / 12 |
| Pro-R320A | 2M track with double end cap.(200cm) | Aluminum Extrusion | White □ Silver ■ Black ■ | 1 / 12 |
| Pro-R330A | 3M track with double end cap.(300cm) | Aluminum Extrusion | White □ Silver ■ Black ■ | 1 / 12 |
| Pro-R3400A | 4M track with double end cap.(400cm) | Aluminum Extrusion | White □ Silver ■ Black ■ | 1 / 9 |
| Pro-R302A | 2'track with double end cap actual length24" | Aluminum Extrusion | White □ Silver ■ Black ■ | 1 / 12 |
| Pro-R304A | 4'track with double end cap actual length48" | Aluminum Extrusion | White □ Silver ■ Black ■ | 1 / 12 |
| Pro-R306A | 6'track with double end cap actual length72" | Aluminum Extrusion | White □ Silver ■ Black ■ | 1 / 12 |
| Pro-R308A | 8'track with double end cap actual length96" | Aluminum Extrusion | White □ Silver ■ Black ■ | 1 / 12 |

Live-end Connector Cover



| Model No. | Package | Colour |
|------------|---------|----------|
| Pro-R331-W | 1 / 500 | White □ |
| Pro-R331-S | 1 / 500 | Silver ■ |
| Pro-R331-B | 1 / 500 | Black ■ |

"L" Connector Cover

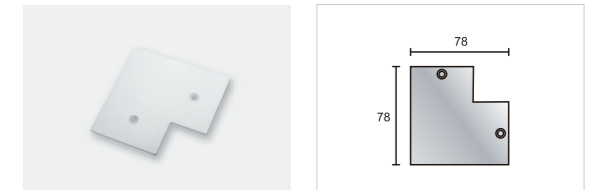

| Model No. | Package | Colour |
|------------|---------|----------|
| Pro-R335-W | 1 / 400 | White □ |
| Pro-R335-S | 1 / 400 | Silver ■ |
| Pro-R335-B | 1 / 400 | Black ■ |

Middle Connector Cover

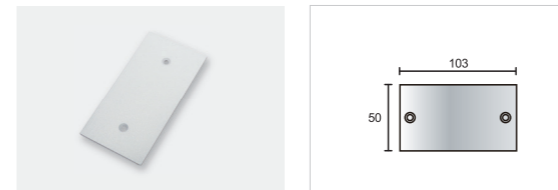

| Model No. | Package | Colour |
|------------|---------|----------|
| Pro-R334-W | 1 / 400 | White □ |
| Pro-R334-S | 1 / 400 | Silver ■ |
| Pro-R334-B | 1 / 400 | Black ■ |

"T" Connector Cover

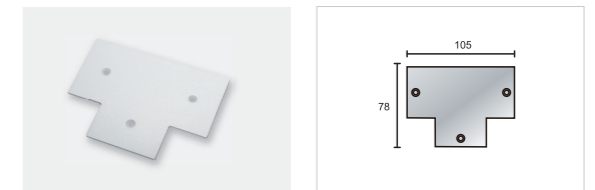

| Model No. | Package | Colour |
|------------|---------|----------|
| Pro-R336-W | 1 / 400 | White □ |
| Pro-R336-S | 1 / 400 | Silver ■ |
| Pro-R336-B | 1 / 400 | Black ■ |

"+" Connector Cover

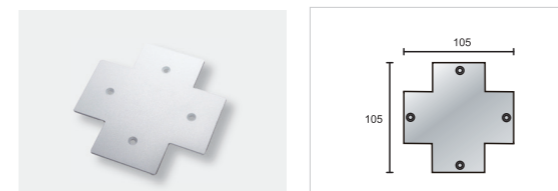

| Model No. | Package | Colour |
|------------|---------|----------|
| Pro-R337-W | 1 / 400 | White □ |
| Pro-R337-S | 1 / 400 | Silver ■ |
| Pro-R337-B | 1 / 400 | Black ■ |

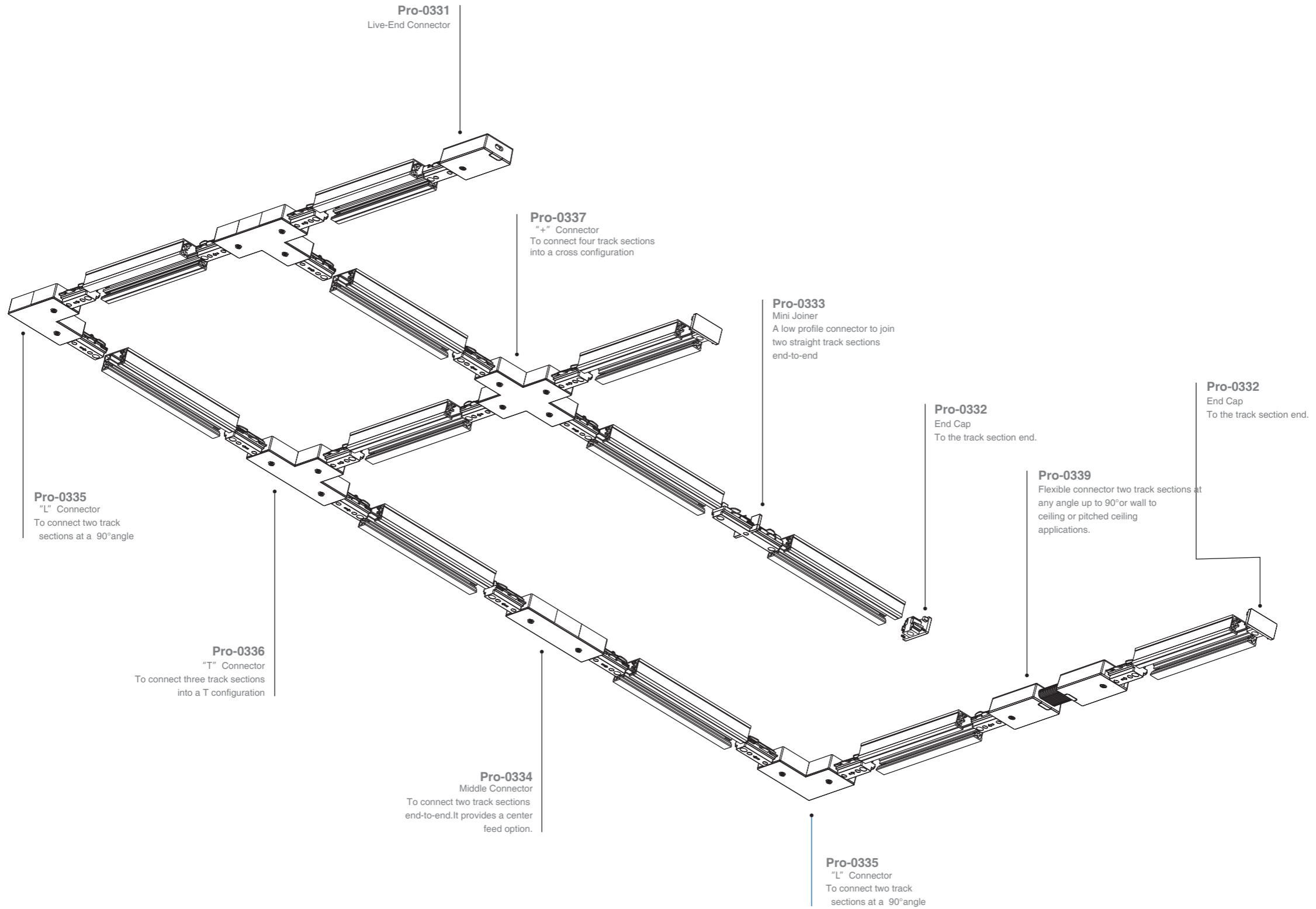

Live-End Connector



| Model No. | Package | Colour |
|------------|---------|----------|
| Pro-0331-W | 1 / 150 | White □ |
| Pro-0331-S | 1 / 150 | Silver ■ |
| Pro-0331-B | 1 / 150 | Black ■ |

Mini Joiner



| Model No. | Package | Colour |
|------------|---------|----------|
| Pro-0333-W | 1 / 400 | White □ |
| Pro-0333-S | 1 / 400 | Silver ■ |
| Pro-0333-B | 1 / 400 | Black ■ |

End Cap



| Model No. | Package | Colour |
|------------|----------|----------|
| Pro-0332-W | 1 / 1000 | White □ |
| Pro-0332-S | 1 / 1000 | Silver ■ |
| Pro-0332-B | 1 / 1000 | Black ■ |

Floating canopy

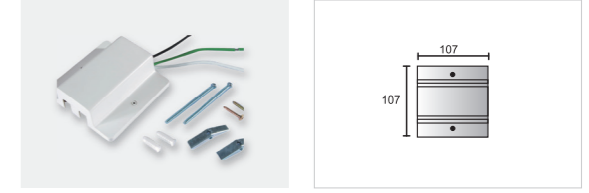

| Model No. | Package | Colour |
|------------|---------|----------|
| Pro-0341-W | 1 / 60 | White □ |
| Pro-0341-S | 1 / 60 | Silver ■ |
| Pro-0341-B | 1 / 60 | Black ■ |

Middle Connector

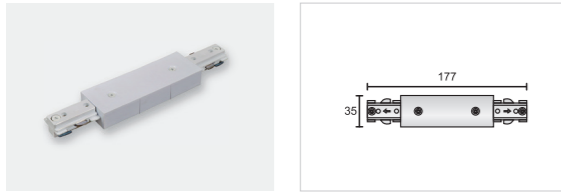

| Model No. | Package | Colour |
|------------|---------|----------|
| Pro-0334-W | 1 / 228 | White □ |
| Pro-0334-S | 1 / 228 | Silver ■ |
| Pro-0334-B | 1 / 228 | Black ■ |

“L” Connector



| Model No. | Package | Colour |
|------------|---------|----------|
| Pro-0335-W | 1 / 160 | White □ |
| Pro-0335-S | 1 / 160 | Silver ■ |
| Pro-0335-B | 1 / 160 | Black ■ |

Outlet box cover



| Model No. | Package | Colour |
|------------|---------|----------|
| Pro-0342-W | 1 / 200 | White □ |
| Pro-0342-S | 1 / 200 | Silver ■ |
| Pro-0342-B | 1 / 200 | Black ■ |

Monopoint



| Model No. | Package | Colour |
|------------|---------|----------|
| Pro-0343-W | 1 / 200 | White □ |
| Pro-0343-S | 1 / 200 | Silver ■ |
| Pro-0343-B | 1 / 200 | Black ■ |

Suspension kit

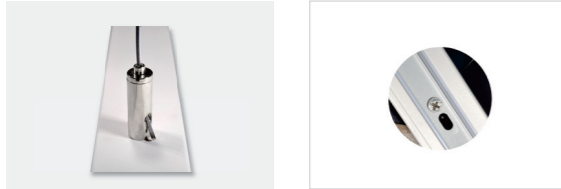

| Model No. | Package | Colour |
|------------|---------|----------|
| Pro-0348-W | 1 / 500 | White □ |
| Pro-0348-S | 1 / 500 | Silver ■ |
| Pro-0348-B | 1 / 500 | Black ■ |

“T” Connector



| Model No. | Package | Colour |
|------------|---------|----------|
| Pro-0336-W | 1 / 108 | White □ |
| Pro-0336-S | 1 / 108 | Silver ■ |
| Pro-0336-B | 1 / 108 | Black ■ |

“+” Connector



| Model No. | Package | Colour |
|------------|---------|----------|
| Pro-0337-W | 1 / 60 | White □ |
| Pro-0337-S | 1 / 60 | Silver ■ |
| Pro-0337-B | 1 / 60 | Black ■ |

Flexible Connector



| Model No. | Package | Colour |
|------------|---------|----------|
| Pro-0339-W | 1 / 60 | White □ |
| Pro-0339-S | 1 / 60 | Silver ■ |
| Pro-0339-B | 1 / 60 | Black ■ |